

Indoor / Outdoor Sealing Kit For R620 ST

Use this instruction in conjunction with unit instruction manual (Doc. XG0773)

Follow the instructions for the unit installation in the up to Step 1 on Page 7 of the installation guide.

The unit is in place with the screws removed as illustrated there.

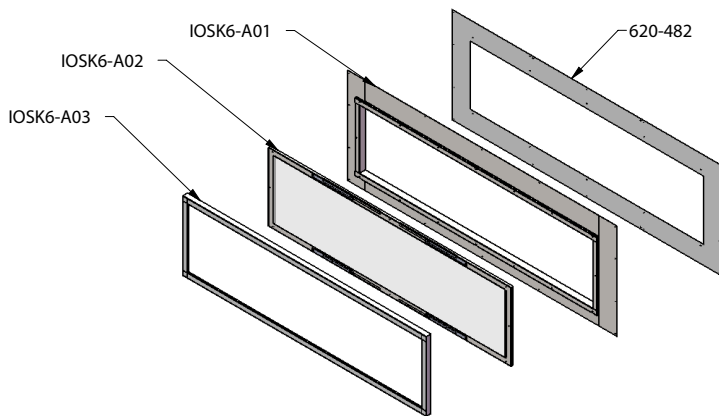

Figure 1: Indoor/ Outdoor Sealing Kit Components

STEP 1: Back frame the unit with the metal header supplied by Montigo above the unit and either combustible or non-combustible framing to the sides and bottom maintaining clearances as shown and ensuring the galvanized apron (Fig 1, Part No. 620-482) can be attached to the framing.

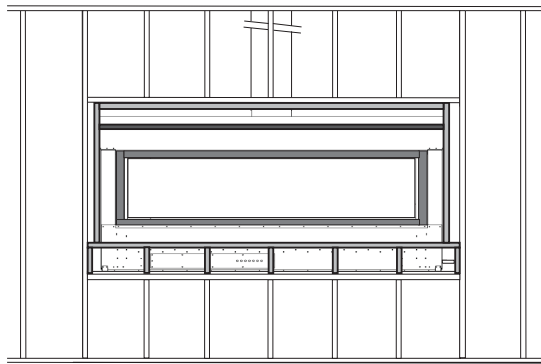

Figure 2: Backframe unit

CLEARANCE TO COMBUSTIBLES:

6" Top, 3" each side, 3" bottom from the protruding window box.

STEP 2: Place the galvanized apron and attach to the unit using the 6 screws removed from the unit face, Figure 3.

STEP 3: Install the silicon gasket material (supplied by Montigo) in one continuous strip with the joint at the bottom, Figure 4.



Figure 3: Attach galvanized apron to unit



Figure 4: Install silicone gasket

STEP 4: Attach the stainless steel frame (Fig. 1, Part No. IOSK6-A01) to the galvanized frame lining up the holes around perimeter. Secure in place through holes across the top and down the sides. Do not secure the bottom flange.

STEP 5: Apply approved waterproofing membrane over the flange of the frame on the top and sides and under the flange of the frame at the bottom. The membrane should overlap the frame approximately 2" around the perimeter.

STEP 6: All facing materials may now be installed over the frame. **BE CERTAIN TO MAINTAIN 6" ABOVE AND 3" ON SIDES AND BOTTOM TO ANY COMBUSTIBLE MATERIAL**

STEP 7: Mount the framed glass (Fig 1, IOSK6-A02) onto the unit and secure in place first with only the two side screws.

STEP 8: Place the Galvanized strips (4 supplied) at each corner lining up screw holes and secure both the strips and the framed glass to the unit.

STEP 9: Attach the stainless steel trim (Fig1, IOSK6-A03), by placing it on and ensuring the magnets catch the previously placed galvanized strip.

IOSK 620 Instructions Cont'd

