

CFPO-S24
 Square Firepit
Bottom Intake

**PRELIMINARY
 DRAWING ONLY** 

EXAMPLE CONFIGURATION	UNLESS OTHERWISE SPECIFIED	DATE
MONTIGO COMMERCIAL FIREPLACES ARE CUSTOM BUILT FOR EACH PROJECT. THIS DRAWING IS FOR REFERENCE ONLY. FLUE AND AIR INTAKE SIZES ARE SUBJECT TO CHANGE DEPENDING ON VENT RUN.	DIMENSIONS ARE IN INCHES TOLERANCES: FRACTIONAL $\pm 1/8"$	28/08/2020



the art of **fireplaces**
www.montigo.com

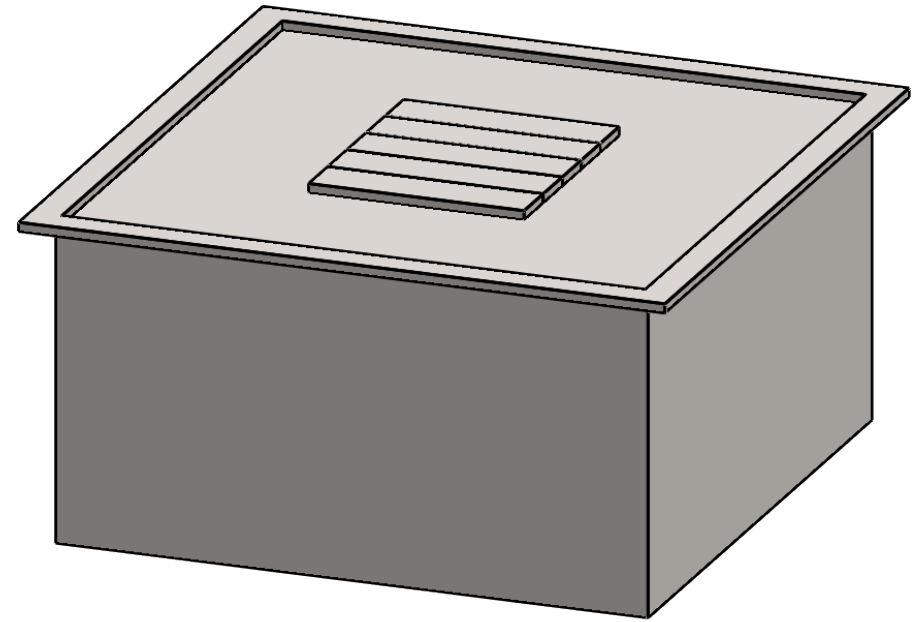
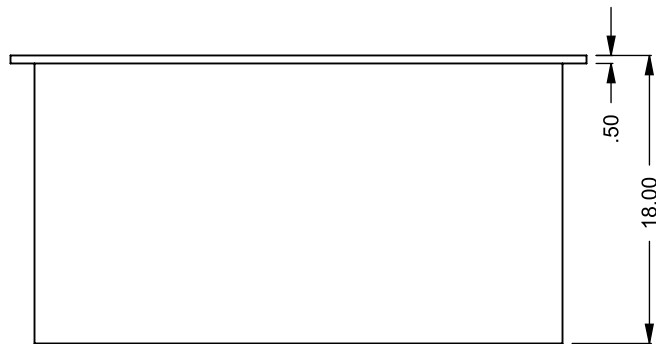
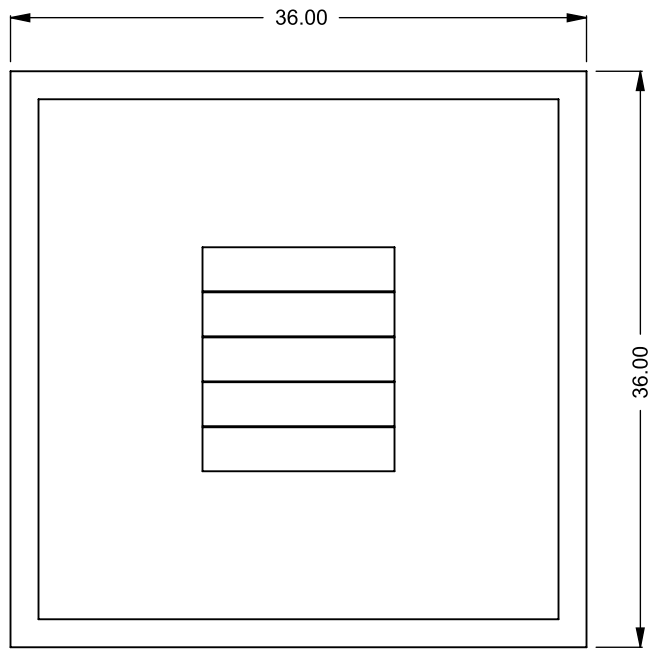

CFPO-S36
 Square Firepit
Bottom Intake

**PRELIMINARY
 DRAWING ONLY** 

EXAMPLE CONFIGURATION	UNLESS OTHERWISE SPECIFIED	DATE
MONTIGO COMMERCIAL FIREPLACES ARE CUSTOM BUILT FOR EACH PROJECT. THIS DRAWING IS FOR REFERENCE ONLY. FLUE AND AIR INTAKE SIZES ARE SUBJECT TO CHANGE DEPENDING ON VENT RUN.	DIMENSIONS ARE IN INCHES TOLERANCES: FRACTIONAL $\pm 1/8"$	28/08/2020

MONTIGO
 the art of **fireplaces**
www.montigo.com

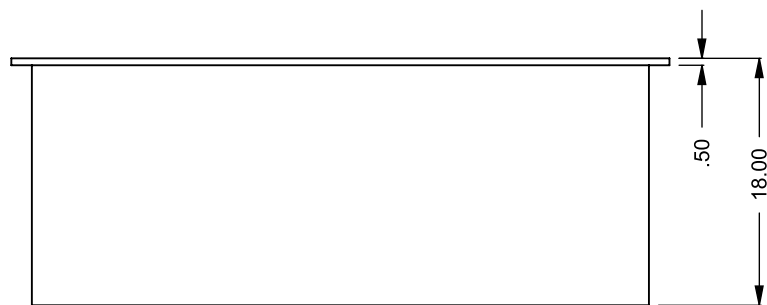
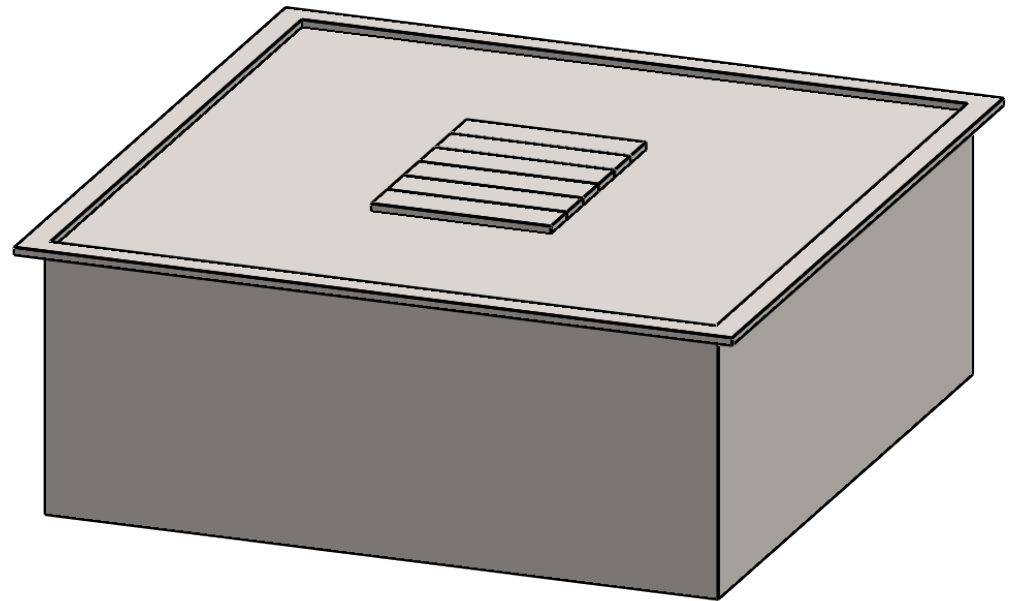
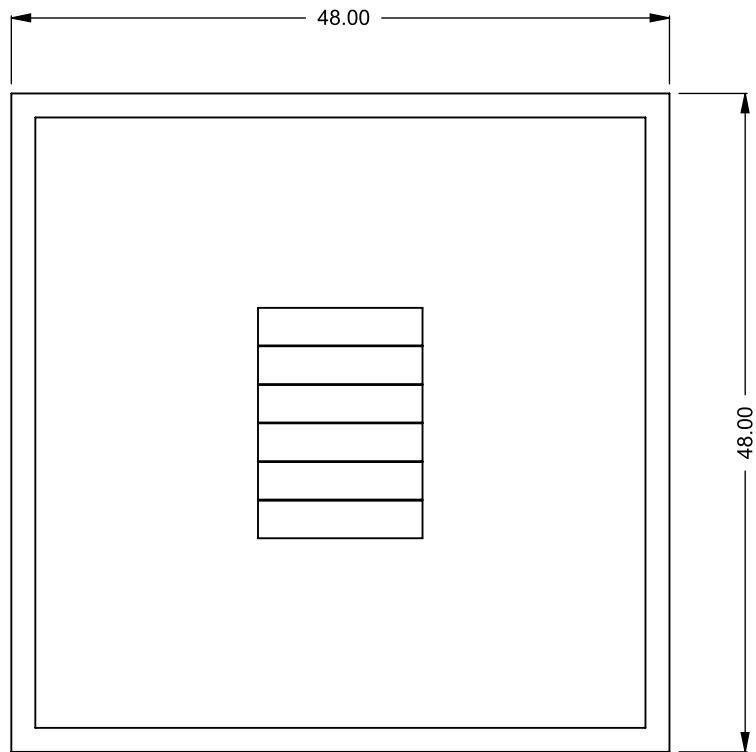

CFPO-S48
 Square Firepit
Bottom Intake

**PRELIMINARY
 DRAWING ONLY** 

EXAMPLE CONFIGURATION	UNLESS OTHERWISE SPECIFIED	DATE
MONTIGO COMMERCIAL FIREPLACES ARE CUSTOM BUILT FOR EACH PROJECT. THIS DRAWING IS FOR REFERENCE ONLY. FLUE AND AIR INTAKE SIZES ARE SUBJECT TO CHANGE DEPENDING ON VENT RUN.	DIMENSIONS ARE IN INCHES TOLERANCES: FRACTIONAL $\pm 1/8"$	28/08/2020

MONTIGO
 the art of **fireplaces**
www.montigo.com

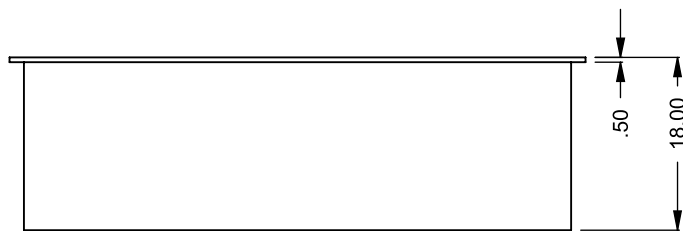
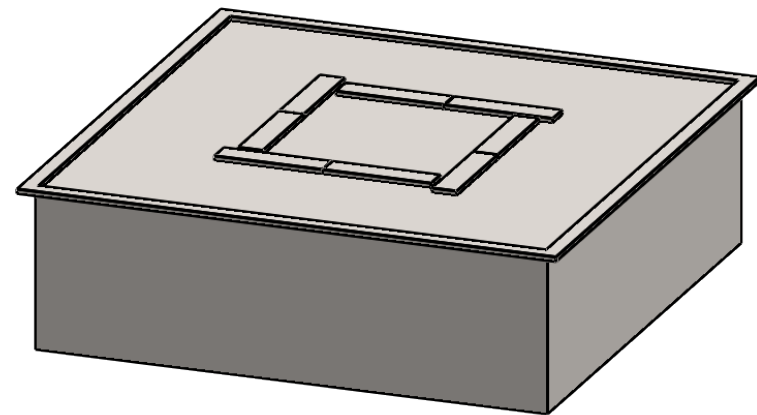
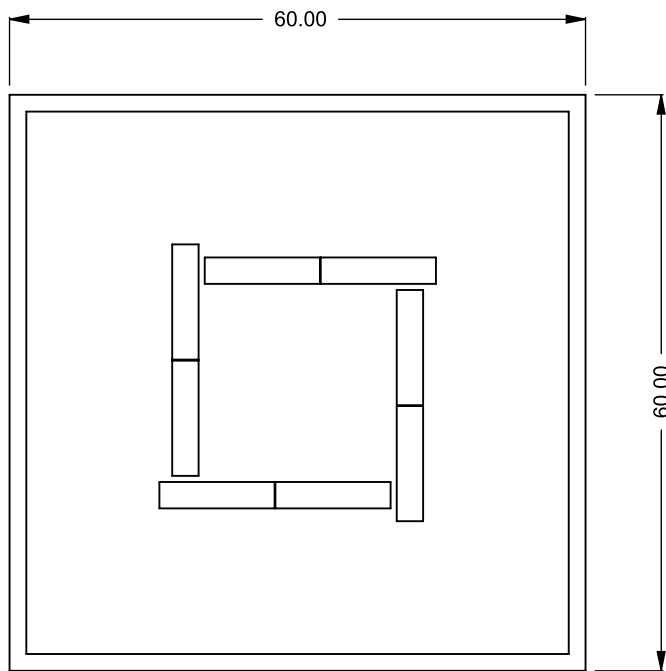

CFPO-S60
 Square Firepit
Bottom Intake

**PRELIMINARY
 DRAWING ONLY** 

EXAMPLE CONFIGURATION	UNLESS OTHERWISE SPECIFIED	DATE
MONTIGO COMMERCIAL FIREPLACES ARE CUSTOM BUILT FOR EACH PROJECT. THIS DRAWING IS FOR REFERENCE ONLY. FLUE AND AIR INTAKE SIZES ARE SUBJECT TO CHANGE DEPENDING ON VENT RUN.	DIMENSIONS ARE IN INCHES TOLERANCES: FRACTIONAL $\pm 1/8"$	28/08/2020

MONTIGO
 the art of **fireplaces**
www.montigo.com