

# Installation & Maintenance Manual

**MONTIGO**<sup>®</sup>  
the art of **fireplaces**

## Exemplar R324 INDOOR/OUTDOOR GAS FIREPLACE

50,000 BTU/hr Natural Gas or Propane Gas

### IMPORTANT

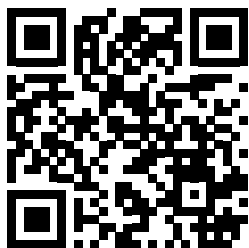

SCAN THE QR CODE OR VISIT THE WEBSITE TO VIEW THE MOST RECENT VERSION OF THE MANUAL

WWW.MONTIGO.COM/PRODUCT-GUIDES



- The installation of this fireplace must be done by a qualified and certified gas appliance installer.
- Check local codes and read all instructions prior to installation.

**⚠ WARNING:**  
**FIRE OR EXPLOSION HAZARD**  
Failure to follow safety warnings exactly could result in serious injury, death, or property damage.

- Do not store or use gasoline or other flammable vapors and liquids in the vicinity of this or any other appliance.
- WHAT TO DO IF YOU SMELL GAS
  - Do not try to light any appliance.
  - Do not touch any electrical switch; do not use any phone in your building.
  - Leave the building immediately.
  - Immediately call your gas supplier from a neighbour's phone. Follow the gas supplier's instructions.
  - If you cannot reach your gas supplier, call the fire department.
- Installation and service must be performed by a qualified installer, service agency or the gas fitter.

### ⚠ DANGER



**HOT GLASS WILL CAUSE BURNS.**  
**DO NOT TOUCH GLASS UNTIL COOLED.**  
**NEVER ALLOW CHILDREN TO TOUCH GLASS.**

A barrier designed to reduce the risk of burns from the hot viewing glass is provided with this appliance and must be installed for the protection of children and other at-risk individuals.

### ⚠ WARNING

Some materials used in the manufacturing process of this product can expose you to Benzene which is known in the State of California to cause cancer and birth defects or other reproductive harm. For more information go to [www.P65warnings.ca.gov](http://www.P65warnings.ca.gov)

### ⚠ CAUTION

Installation and service must be performed by a qualified installer, service agency or the gas fitter.

### ⚠ DANGER

Read and understand this manual. Improper installation, adjustment, alteration, service or maintenance can cause serious injury, property damage or even death. For assistance or additional information consult a qualified installer, service agency or the gas supplier.

### ⚠ WARNING

#### CARBON MONOXIDE HAZARD

This appliance can produce carbon monoxide which has no odour. Using it in an enclosed space can kill you. Never use this appliance in an enclosed space such as a camper, tent, car or motorhome.

## Safety Alert Key

### DANGER

Indicates a hazardous situation which, if not avoided, WILL result in death or serious injury or property damage.

### WARNING

Indicates a hazardous situation which, if not avoided, COULD result in death or serious injury or property damage.

### CAUTION

Indicates a hazardous situation which, if not avoided, WILL result in minor or moderate injury.

### NOTICE

Indicates practices that are important, but not related to personal injury.

## Introduction

### Congratulations on your purchase of a Montigo Fireplace.

With over 30 years of experience, Montigo is committed to providing you with a gas fireplace that is not only a beautiful addition to your space, but that is also designed and manufactured to the highest safety, reliability and engineering standards.

We strongly encourage you to read and carefully follow the instructions laid out in this Installation, Operation and Maintenance Manual and retain it for your future reference. Pay special attention to all cautions, warnings, and notices throughout this manual intended to ensure your safety.

This manual covers installation, operation and maintenance. Lighting, operation and care of this fireplace can be easily performed by the homeowner. All installation and service work should be performed by a qualified or licensed installer, plumber or gas fitter as certified by the state, province, region or governing body where the fireplace is being installed.

This installation, operation and maintenance manual is applicable to the models described in Table 1. Refer to your rating plate to verify included options.

### Warranty and Installation Information: (See Appendix B)

The Montigo warranty will be voided by, and Montigo disclaims any responsibility for, the following actions:

- Modification of the fireplace and/or components including Direct-Vent assembly or glass doors.
- Use of any component part not manufactured or approved by Montigo in combination with this Montigo fireplace system.
- Installation other than as instructed in this manual.
- Consult your local Gas Inspection Branch on installation requirements for factory-built gas fireplaces. Installation & repairs should be done by a qualified contractor.

## Replacement Parts

### Honeywell HSI

| Part   | R324-ST   |
|--|-----------|
| NG Gas Valve                                 | RGC1004   |
| Propane Gas Valve                            | RGC1003   |
| NG Pilot Assembly                            | RPA003    |
| Propane Pilot Assembly                       | RPA004    |
| Power Vent Control Box                       | RESCB2    |
| Replacement Screen                           | RSCR320   |
| Fuse, AGC-5Amp                               | REC1122   |
| 275 deg F Manual Reset Switch                | REC1073   |
| Vacuum Switch                                | REC1226   |
| Outdoor Glass (for fireplace without screen) | RD324ST01 |
| Outdoor Glass (for fireplace with screen)    | RDT324OD  |
| Indoor Glass                                 | RD324ST02 |
| Outdoor Screen                               | RSCR324OD |
| Indoor Screen                                | RSCR324ID |

### NOTICE

Vented decorative gas appliance:  
not a source of heat; not for use with solid fuel

## Contents

|   |           |   |           |
|---|-----------|---|-----------|
| <b>Safety Alert Key</b> .....                                 | <b>2</b>  | <b>Appendix A: Warranty</b> .....   | <b>21</b> |
| <b>Introduction</b> .....                                     | <b>2</b>  | <b>Appendix B: Amendment<br/>(Gas Fireplace / Equipment sold in the State of Massachusetts)</b> ..... | <b>22</b> |
| <b>Replacement Parts</b> .....                                | <b>2</b>  | <b>Appendix C: Canadian Installation Notice</b> .....   | <b>23</b> |
| <b>Contents</b> .....   | <b>3</b>  | Canadian Installations .....  | 23        |
| Section A: Before You Begin .....                             | 4         |   |           |
| Installation Checklist .....                                  | 4         |   |           |
| Standard Installation Checklist.....                          | 5         |   |           |
| <b>Section 1: Product Dimensions</b> .....                    | <b>6</b>  |   |           |
| Rating Plate Sample .....                                     | 6         |   |           |
| <b>Section 2: Framing</b> .....                               | <b>7</b>  |   |           |
| Clearances.....   | 7         |   |           |
| <b>Section 3: Installing the gas line</b> .....               | <b>8</b>  |   |           |
| Fuel Consumption .....  | 8         |   |           |
| Gas Pressure .....  | 8         |   |           |
| Section 5-3: GAS CONNECTION .....                             | 8         |   |           |
| <b>Section 4: Wiring</b> .....                                | <b>9</b>  |   |           |
| Electrical Connection .....                                   | 9         |   |           |
| Accessing the Control Panel .....                             | 10        |   |           |
| <b>Section 5: Finishing</b> .....                             | <b>11</b> |   |           |
| Finishing the unit on the exterior of the building.....       | 11        |   |           |
| Finishing the unit on the interior of the building.....       | 13        |   |           |
| <b>Section 6: Removing the Interior Screen and Door</b> ..... | <b>14</b> |   |           |
| Removing & Installing the Interior Screen and Door.....       | 14        |   |           |
| Removing & Installing the Outside Screen and Door.....        | 14        |   |           |
| <b>Section 7: Installing the Accessories</b> .....            | <b>15</b> |   |           |
| Installing the Firestones.....                                | 15        |   |           |
| Installing Optional Speckled Stones .....                     | 15        |   |           |
| Optional River Rocks.....                                     | 15        |   |           |
| Optional Log Set .....  | 16        |   |           |
| <b>Section 8: Cleaning and Maintenance</b> .....              | <b>20</b> |   |           |
| General.....  | 20        |   |           |
| Cleaning .....  | 20        |   |           |
| Procedure for resetting Temperature Limit Switch .....        | 20        |   |           |
| Pilot burner adjustment.....                                  | 20        |   |           |

## Section A: Before You Begin

### IMPORTANT MESSAGE: SAVE THESE INSTRUCTIONS

The R324 fireplace must be installed in accordance with these instructions. Carefully read all the instructions in this manual first. Consult the Local Gas Branch to determine the need for a permit prior to starting the installation. It is the responsibility of the installer to ensure this fireplace is installed in compliance with the manufacturers instructions and all applicable codes.

### NOTICE

Do not use this appliance if any part has been under water. Immediately call a qualified service technician to inspect the appliance and to replace any part of the control system and any gas control that has been under water

### NOTICE

Due to high temperatures, the appliance should be located out of traffic and away from furniture and draperies

### NOTICE

Children and adults should be alerted to the hazards of high surface temperature and should stay away to avoid burns or clothing ignition

### NOTICE

A barrier designed to reduce the risk of burns from the hot viewing glass is provided with this appliance and shall be installed for the protection of children and other at-risk individuals

### NOTICE

Installation and repair should be done by a qualified service person. The appliance should be inspected before use and at least annually by a professional service person. More frequent cleaning might be required due to excessive lint from carpeting, bedding material, etc. It is imperative that control compartments, burners, and circulating air passageways of the appliance be kept clean

## Installation Checklist

- Determine the desired install location of your fireplace.
- See Section 1, Dimensions, and refer to the Framing Section 2 for details.
- The electrical panel is located on the lower right side when facing the interior side of the fireplace.
- Montigo supplies 20' of low voltage wire, which can be spliced to any length. This wire CANNOT run in conduit with any other wire.
- Refer to Section 4, Wiring for Details.
- The gas connection is located on the lower left when facing the interior side of the fireplace.
- Refer to local codes and guidelines for installation requirements.
- Locate unit rating plate under media tray on indoor side.
- Installation and repairs should be done by a qualified contractor and must conform to:
  - Installations in Canada must conform to the current CAN/CGA B-149.1 and .2 Gas Installation Code and local regulations.
  - Installations in the USA must conform to local codes, or in the absence of local codes to the National Fuel Gas Code, ANSI Z223.1
  - Unit must be raised 10" from the grade. (USA Only)
  - See Appendix B for installation within the State of Massachusetts. This fireplace must comply with NFPA-54 Chapter 10.
- Refer to Section 4, "Installing the Gas Line" for Details.

### Understanding the Basic Operation

The control compartment of this fireplace is located in the bottom of the fireplace right below the burner system. Accessible from the indoor side, all models will be supplied with a Honeywell smart valve gas control and will not have a variable flame control. There is one air switch that is controlling the gas control system, and is located in the bottom of this fireplace. These gas valves, and pressure switches communicate with the electrical control panel .

To operate the fireplace, Montigo has supplied and installed twenty feet of low voltage wire to this electrical control panel. Connect the two wire harness to a standard single pole ON/Off switch located at a location of your choice. You may also extend these wires up to 100', as long as you select a wire of equal quality. DO NOT CONNECT ANY POWER TO THIS WIRE.

Unit MUST be installed on an exterior wall. It cannot be installed fully indoors or fully outdoors.

### NOTICE

Clothing or other flammable material should not be placed on or near the appliance



## Standard Installation Checklist

This standard installation checklist is to be used by the installer in conjunction with, not instead of, the instructions contained within this installation manual.

|                          |                              |
|--------------------------|------------------------------|
| Customer _____           | Date Installed: _____        |
| Install Address: _____   | Location of Fireplace: _____ |
| _____                    | Installer: _____             |
| Model (circle one): R324 | Dealer Phone: _____          |
|                          | Serial #: _____              |

|  | YES | NO | IF NO, WHY NOT? |
|--|-----|----|-----------------|
| <b>Appliance Install: Section 2</b>                                  |     |    |                 |
| Framing complies with install manual.                                |     |    |                 |
| Standoffs have been installed.                                       |     |    |                 |
| Proper clearances have been maintained.                              |     |    |                 |
| <b>Wiring/Electrical/Gas: Section 3-4</b>                            |     |    |                 |
| Proper appliance for fuel type.                                      |     |    |                 |
| Was a conversion performed?  |     |    |                 |
| Leak check performed & inlet pressure verified.                      |     |    |                 |
| Unswitched power provided to the appliance PPO box.                  |     |    |                 |
| Low voltage wire connected to dry contact wall switch (non-powered)* |     |    |                 |
| <b>Finishing: Section 5</b>  |     |    |                 |
| Only non-combustible materials installed in non-combustible areas.   |     |    |                 |
| Clearances meet installation manual requirements                     |     |    |                 |
| Mantels and/or projections comply with install manual                |     |    |                 |
| <b>Appliance Setup: Section 6 through 8</b>                          |     |    |                 |
| Media, door, and screen installed according to install manual        |     |    |                 |
| Manual given to home owner.  |     |    |                 |
| Started appliance and verified no gas leaks exist.                   |     |    |                 |
| <b>Comments:</b>   |     |    |                 |
|  |     |    |                 |
|  |     |    |                 |

## Rating Plate Sample

**Do Not Remove This Label**  
N'enlevez Pas Cette Etiquette

Type: **Outdoor Decorative/Vented Decorative Gas Appliance**  
Not for use with solid fuel. / Pas pour l'usage avec le combustible solide.  
Not for use with air filters. / Pas pour l'usage avec des filtres à air.

Model No. Modèle: R324-ST-IO-I

Serial No.: 2-171019-000000

Manufacturer / Fabricant: Canadian Heating Products Inc., Langley BC, www.montigo.com  
Montigo DelRay Corp., Ferndale, WA, www.montigo.com

Tested To / Examiné À: **ANSI Z21.97/ CSA 2.41-2014 and ANSI Z21.50/ CSA 2.22-2014**

Electrical Rating / Estimation Électrique: 115V / 1Ph / 60Hz / less than 12A

Altitude Rating / Estimation D'Altitude: N & H (0 - 4500 ft. / 0 - 1371 m).

Fuel Type / Type De Carburant:

Natural Gas / Gaz Naturel  
 Propane / Gaz Propane

| Max. Input<br>Max. Entrée<br>BTU/H | Min. Input<br>Min. Entrée<br>BTU/H | Output /<br>Rendement<br>BTU/H | Orifice Size / Taille D'Orifice<br>Front/Avant Rear/Derrière | Gas Manifold<br>Pressure / Pression<br>D'Admission Du Gaz | Min. Gas Supply<br>Pressure/ Min. Pression<br>D'Alimentation Du Gaz |
|------------------------------------|------------------------------------|--------------------------------|--|---|---|
| 50,000                             | 50,000                             | N/A                            | 3@45 DMS / N/A   | 3.5" W.C.   | 5.5" W.C.   |
| 50,000                             | 50,000                             | N/A                            | 3@ 1.25mm / N/A  | 10" W.C.  | 11" W.C.  |

| *Clearance to Combustibles<br>*Degagements Aux Combustibles |      |
|---|------|
| Sides/Côtés:  | 1/2" |
| Back/Derrière:  | NC   |
| Top-Top Vent/Du Haut-Évent Du Haut:                         | 3"   |
| Top-Rear Vent/Du Haut-Évent Arrière:                        | 3"   |
| Floor/Plancher:   | NC   |
| Mantel/Manteau:   | NC   |
| Recess Depth/ Profondeur D'Encadrement:                     | N/C  |
| Flue:   | N/A  |

**FOR USE WITH GLASS DOORS AND SCREENS CERTIFIED WITH THE APPLIANCE ONLY**  
Pour utilisation avec portes de verre et écrans de certifiés avec l'appareil seulement

\*Refer to installation manual for more information.  
\*Référez-vous au manuel d'installation pour plus d'information.

LBL1207D-V5.1 R(P)VIEW\_HSI\_WITH SCREEN\_AUG.17.2015

Figure 1.1 Rating Plate for R324

## The Residential R324STIO fireplace

The fireplaces may be installed in any location that maintains proper clearances to air conditioning ducts, electrical wiring and plumbing. Safety, as well as efficiency of operation, must be considered when selecting the fireplace location. Try to select a location that does not interfere with room traffic, has adequate ventilation, and offers an accessible pathway for Power Vent installation.

## Section 1: Product Dimensions

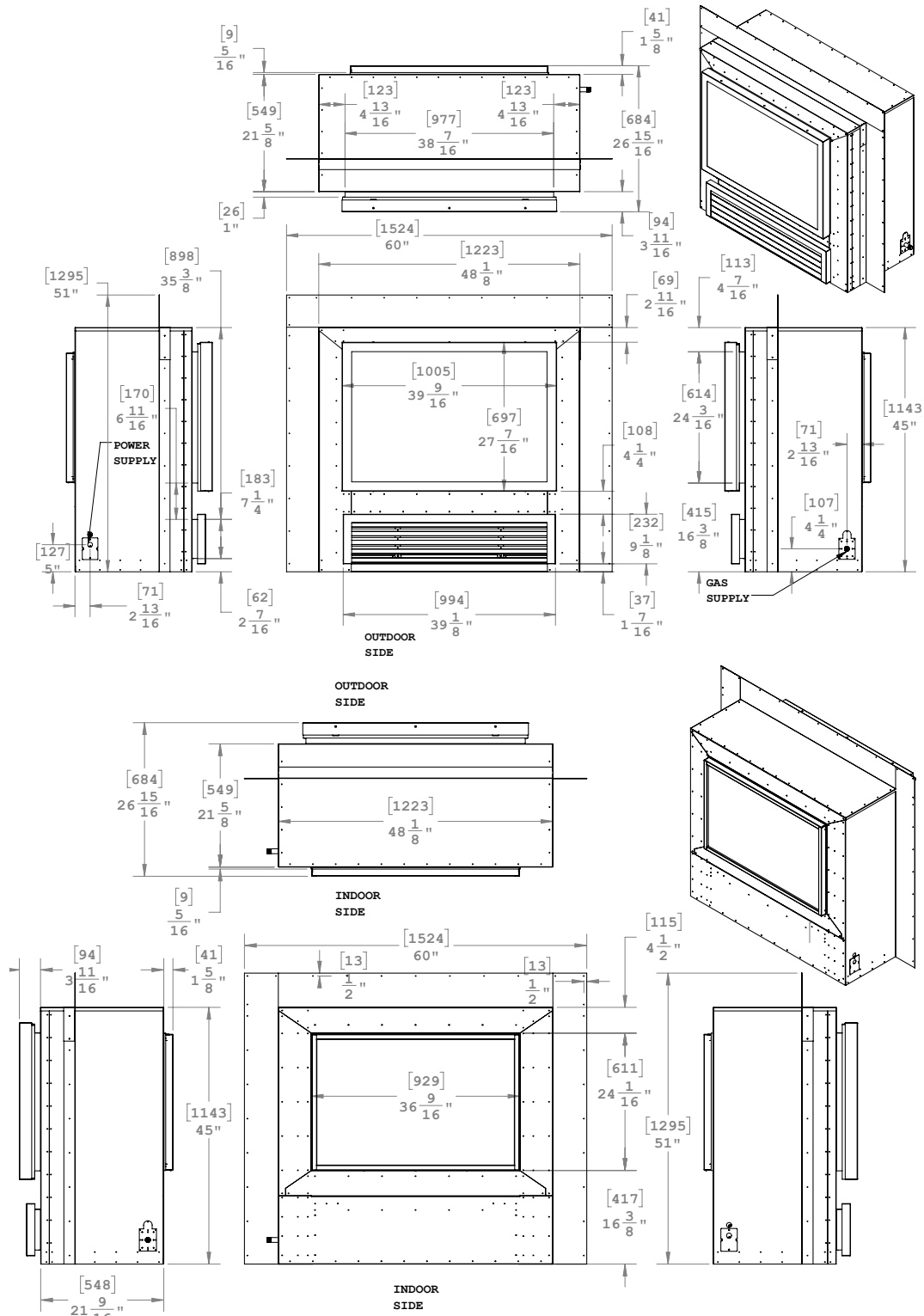

Figure 1. Fireplace dimensions (Tolerance ± 1/8").

## Section 2: Framing

### Step 1:

Frame the opening in the location that you have selected for your fireplace. The dimensions of the opening should be X" wide by Y" high. (See Table)

| Combustible Framing |     |
|---------------------|-----|
| X                   | 49" |
| Y                   | 48" |

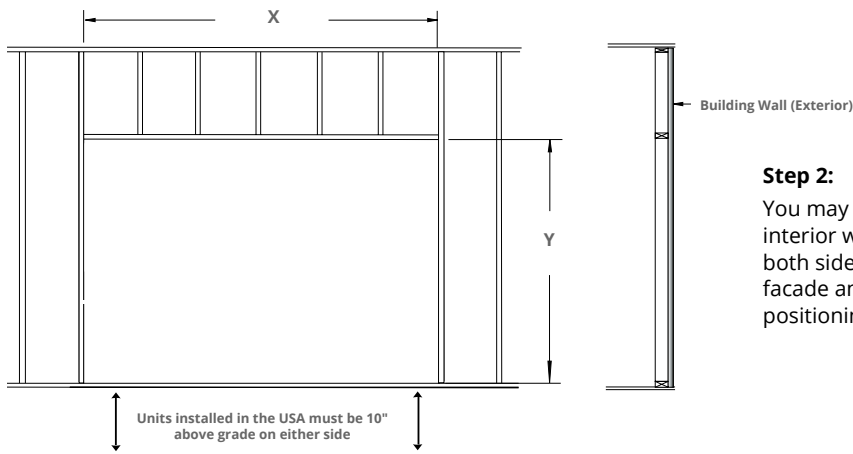

Figure 2.a Framing Dimensions

### Step 2:

You may position the unit in framed opening to be flush to the interior wall, flush to the exterior wall, or partially extending beyond both sides. Be sure to take into account finished surfaces (exterior facade and interior drywall or other finish) when determining final positioning.

## Clearances

When installing a shelf over the top of the fireplace, 3" clearance is required from the top of the fireplace to the underside of any combustible shelf materials. Side clearance is 1/2"

| Clearances    |      |
|---------------|------|
| Sides         | 1/2" |
| Floor Indoor  | 0"   |
| Floor Outdoor | 10"  |
| Top           | 3"   |

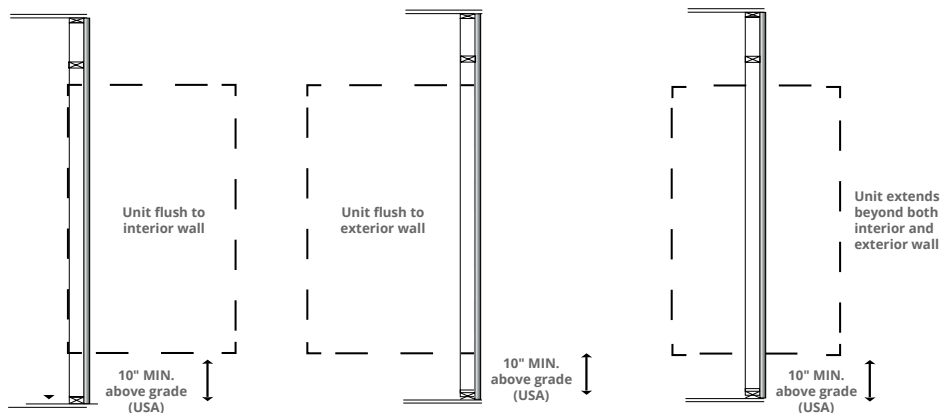
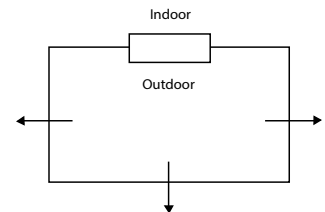

Figure 2.b Framing Clearances



### Note:

For all positions, outside face must be positioned on OPEN non-obstructed patio.

## Section 3: Installing the gas line

### Fuel Consumption

Verify that your fireplace is compatible with your available gas type. (Natural Gas or Propane shown by "N" or "L" in your model number)

If gas type is not compatible, contact your local Montigo representative to purchase a conversion kit.

Conversion kits must be installed by a qualified service technician.

### Gas Pressure

Optimum appliance performance requires proper input pressures.

Gas line sizing requirements will be determined in ANSI Z223.1 National Fuel Gas Code in the USA and CAN/CGA B149 in Canada.

#### Pressure requirements (during operation):

| PRESSURE REQUIREMENTS  |             |            |
|------------------------|-------------|------------|
| Gas Pressure           | Natural Gas | Propane    |
| Minimum inlet pressure | 5.5in. w.c. | 11in. w.c. |
| Manifold pressure      | 3.5in. w.c. | 10in. w.c. |

Figure 20. Pressure Requirements

- The manifold outlet pressure is set from the factory to the appropriate pressure but should be verified.
- To check pressures, control valves have a provision to remove a 1/8" N.P.T. plug to be fitted with a hose barb.
- Montigo requires a service shut off valve be located in an accessible location to isolate the gas supply.
- Only install gas shut-off valves approved for use by the state, province, or other governing body in which the fireplace is being installed.

### Section 5-3: GAS CONNECTION

- See Figure 20.b or 20.c for location of gas line access.
- Connect incoming gas line to the 1/2" gas inlet port.
- Check appliance connection, valve and valve train under normal operating pressure with a commercially available leak check solution.

**DO NOT USE A FLAME OF ANY KIND TO TEST FOR LEAKS.**

### NOTICE

When pressure testing the fireplace, gas line, and input system follow the appropriate local codes for your area. **DO NOT** connect the fireplace to pressures in excess of **1/2lb** This will damage the gas control valve.

### ⚠ DANGER

After gas line is connected, each appliance connection, valve and valve train **MUST** be checked while under normal operating pressure with either a Liquid Solution, or Leak Detection Device, to locate any source of leak. Tighten any areas where bubbling appears or a leak is detected until bubbling stops completely or leak is no longer detected. **DO NOT** use a flame of any kind to test for leaks. A fire or explosion will occur, causing serious injury, property damage or death.

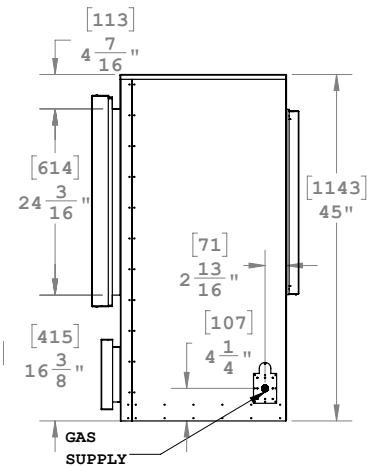

Figure 3. Gas Inlet Supply location, (left-hand side of fireplace facing indoor face).

### ⚠ CAUTION

We recommend careful consideration be given to the effects of elevated mantel temperatures which may be in excess of product design, for example: candles or pictures. This can cause melting, deformation, discolouration or premature failure of TV radio, and other electric components.

### ⚠ CAUTION

When covering the upper portion of the fireplace with a non-combustible material, please note: The decorative facing materials may be subject to temperatures in excess of 250°F. This should be considered when selecting facing materials.



## Section 4: Wiring

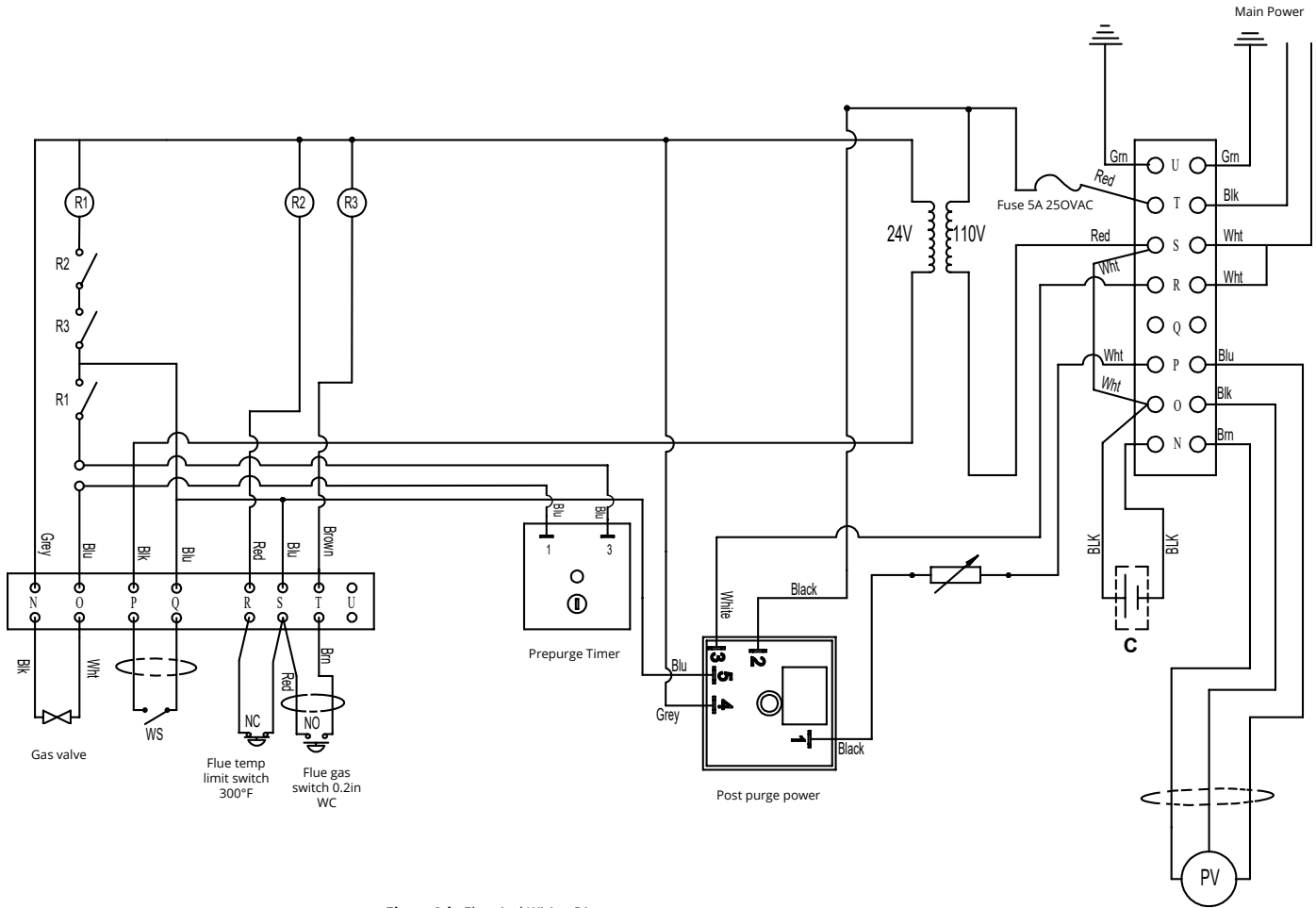

Figure 3.b Electrical Wiring Diagram

### Electrical Connection

- Connect 115 Volt 12 Amp power supply to the connection box located on the right side bottom corner of this fireplace.
- There is 25 Feet of low voltage wire coiled up on the same side of this fireplace.
- Run this low voltage wire to an on / off switch at a location of your choice.
- If this wire is inadequate in length you may replace this wire with any Number 18 gage solid or stranded wire in any length.
- Do not splice these wires. Run a new wire directly from the control board to the switch location.
- Caution: Do not apply any power to these two wires.

## Accessing the Control Panel

**STEP 1:**

Remove screws that secure media tray on the indoor side of the fireplace.  
(both sides)



Figure 4.b Removing screws that secure media tray

**STEP 2:**

Locate door buckles



Figure 4.c Note placement of rating plate

**STEP 3:**

Remove the screws from each side and the middle of the control panel cover.

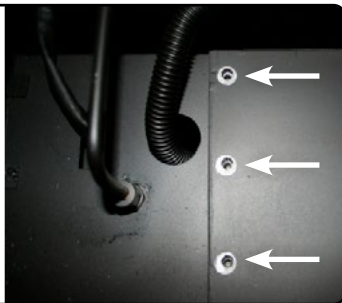

Figure 4.d Removing screws from each side of the control panel cover



Figure 4.e Removing screw from middle of control panel cover

**STEP 4:**

Lift control panel cover out to expose controls.



Figure 4.f Exposing controls under control panel



Figure 4.g Control box controls

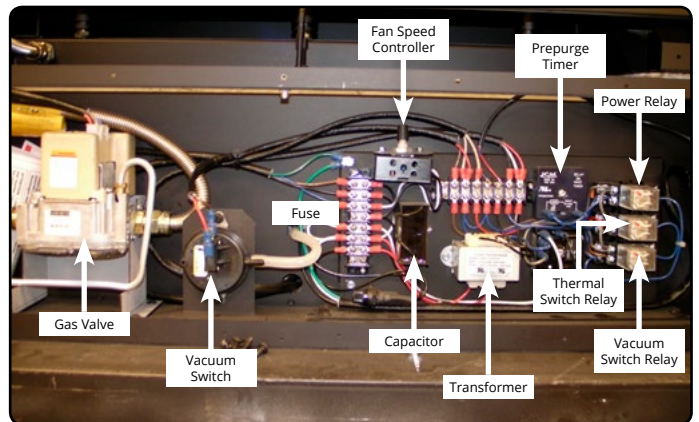

Figure 4.h Control box controls

## Section 5: Finishing

### Finishing the unit on the exterior of the building

#### Step 1

Select a location such that the fireplace floor maintains a 10" clearance above grade (see Fig. 5.e). The power vent module will expel high temperature flue gases through the louvers. When selecting the material for the hearth please keep in mind the potential for discoloration due to high temperatures.

#### Step 2

Determine where the unit will be placed in relation to the exterior wall. Position flashing such that it will be flush to the exterior wall when installed.

#### Step 3

Attach the flashing provided to the fireplace exterior using the sheet metal screws provided. (see Fig.5.a) Apply a bead of silicone to the back of the flashing to ensure a proper seal.

(Please note: You may drill a 1/8" starter hole into the outside skin of the fireplace using the cobalt drill bit provided in your flashing kit.)

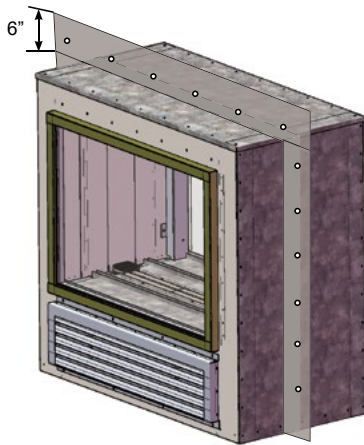
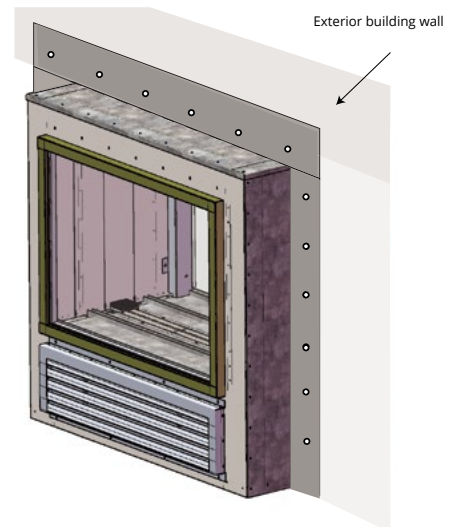

**Figure 5.a** Attach flashing to unit using sheet metal screws provided, apply a bead of silicone to flashing where it meets the unit

#### Step 4

Slide the unit in place into the intended location from the outside of the building until the flashing is flush with the building exterior. (See Fig. 5.b)

Nail the flashing to the exterior sheathing of the building.



**Figure 5.b** Slide unit into place from the outside of the building until the flashing is flush to the exterior wall

#### Step 5

Cover the flashing with approved waterproofing membrane brought to the 1/2" edge of the unit (See Fig. 5.c).

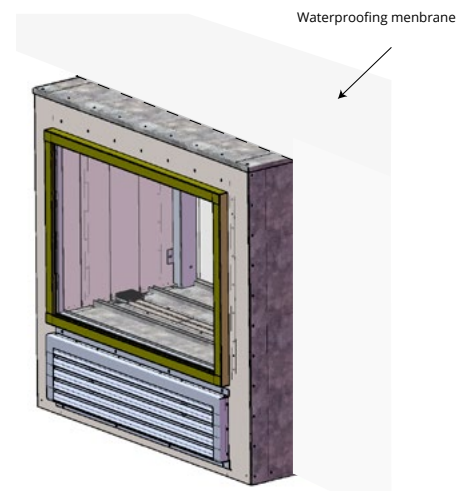

**Figure 5.c** Cover the flashing with the approved waterproofing membrane for the building

## Step 6

Install steel stud construction (or other non-combustible) to create 1/2" clearance on sides and 3" clearance on top before installing finishing materials. (See. 5.d)

(Please note: Ensure that all materials installed on the face of the unit provide adequate clearance to allow the removal of door and louvers as required.)

MAINTAIN CLEARANCE of 1/2" on sides and 3" on top TO ALL COMBUSTIBLE MATERIALS FROM THE UNIT ON SIDES, TOP AND FACE OF THE UNIT

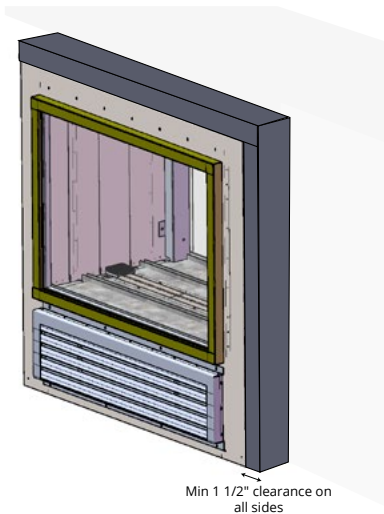

Figure 5.d Install Steel studs for 1/2" clearance on sides and top

## Step 7

Cover face, framed sides and framed top with material of your choosing. ENSURE THERE IS NO OBSTRUCTION IN FRONT OF THE LOUVERS AT ANYTIME AS THIS MAY RESULT IN THE POWER VENT MOTOR OVERHEATING.

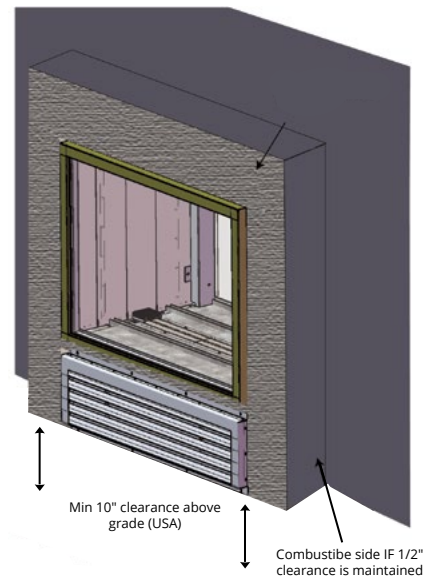

Figure 5.e Clearance above grade

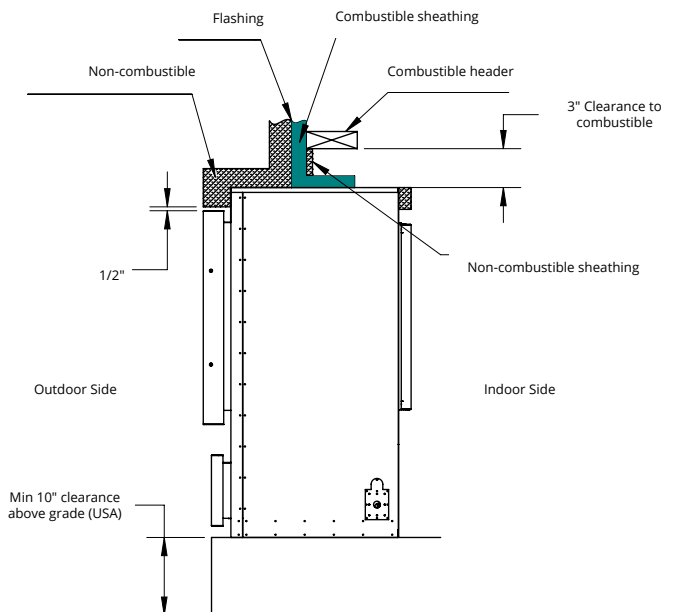

Figure 5.f Non-combustible limits

## NOTICE

### FOR CANADIAN INSTALLATIONS

For Canadian installs, see appendix C for region specific clearances above grade

## Finishing the unit on the interior of the building

### Step 1

Once the unit is in place from the outside, confirm that there is clearance to combustibles; 1/2" on the sides and 3" on the top. (See Fig. 5.g)

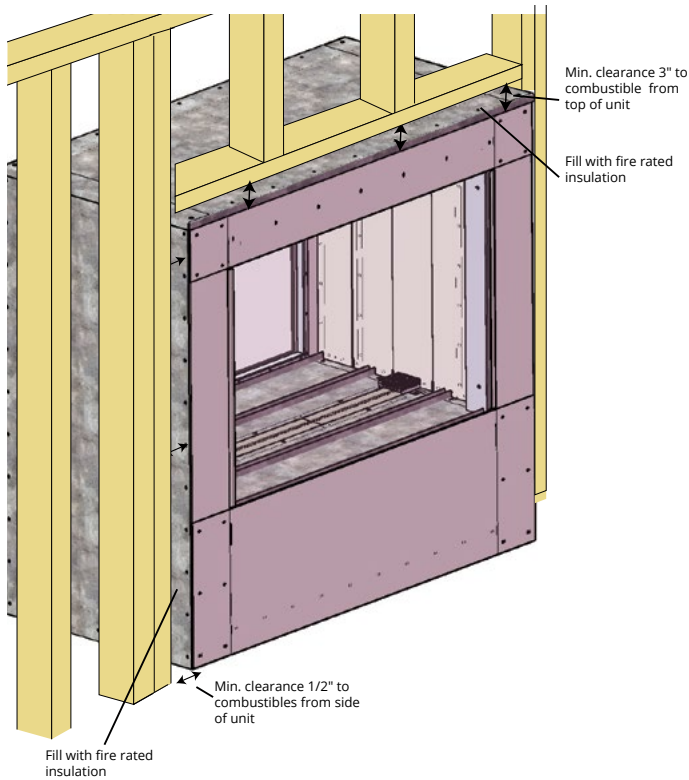

Figure 5.g Interior framing

### Step 2

Fill the gap to sides and top with insulation that is rated for minimum 250 degrees Fahrenheit.

### Step 3

Install non-combustible facing material such as cement board or tile on the front inside face of the unit. (See Fig 5.h)

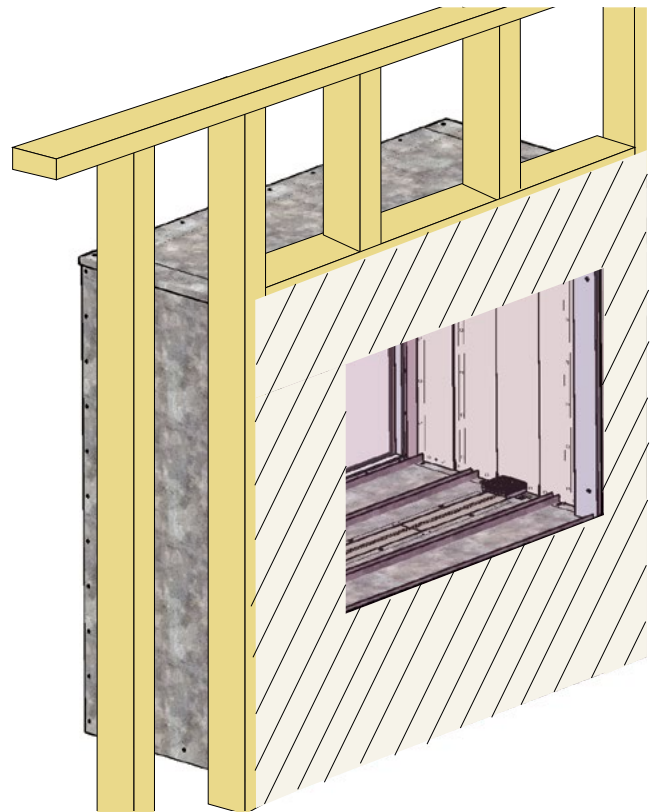

Figure 5.h Interior face of unit - non-combustible

### Step 4

Install drywall or other finishing material.

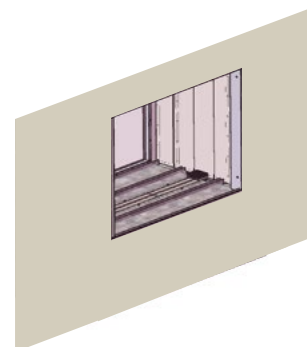

Figure 5.i Finished interior installation



## Section 6: Removing the Interior Screen and Door

### Removing & Installing the Interior Screen and Door

**STEP 1:**

Remove the screen by pulling firmly with your fingers, and remove from the bottom then the top. (See Figure 6.a).



Figure 6.a Removing the screen

**STEP 2:**

Remove the supplied glass lifting tool from the packaging. Place in the center of the Glass door as shown, and activate the suction feature of the tool. NOTE: Read ALL the instruction supplied with the tool

Figure 6.b Supplied Glass lifting tools

**STEP 3:**

Hold the Glass Removal Tools firmly, Lift the door upward, into the top door frame, Figure 6b. Then pull the bottom of the glass door downward, and tilt outward from the bottom fireplace door frame. Figure 6c.

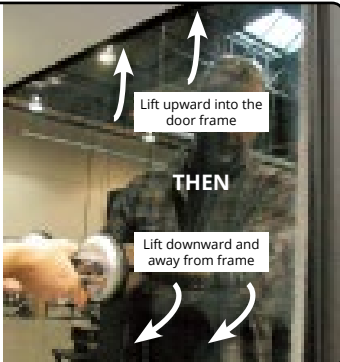

Figure 6.c Supplied Glass lifting tools

**STEP 2:**

Place the door in a safe location while maintenance, cleaning or other operation are in progress. To reinstall, reverse steps.

Figure 6.d Supplied Glass lifting tools

### NOTICE

Any safety screen, guard, or barrier removed for servicing an appliance, must be replaced prior to operating the appliance

### Removing & Installing the Outside Screen and Door

**STEP 1:**

Lift the decorative screen frame up and out, and off of the fireplace.



Figure 6.e Lifting screen frame up and out.

**STEP 2:**

Remove the screws that secure the screen to the unit. Make sure to hold the screen securely as you remove the last few screws to prevent the screen from falling.



Figure 6.f Removing screws that secure screen.

**STEP 3:**

To remove the outer door, remove screws that secure the door to the fireplace. Make sure to hold onto the door securely as you remove the last few screws. To reinstall, reverse steps.



Figure 6.g Removing screws that secure screen.

### CAUTION

Glass doors on gas fireplaces are extremely hot while the fireplace is on and remain hot even after the fireplace has been turned off. Safety screens are mandatory while glass is hot and can reduce the risks of severe burns. Please keep children away from the fireplace at all times.

## Section 7: Installing the Accessories

### Installing the Firestones

The unit is supplied with firestones. Optional fireglass may be purchased from the dealer. Remove the Door as shown in the previous Instruction. Once the glass door is removed place the firestones randomly across the pan and the burners as described.

Note: Only cover the burner with one layer of firestones or fireglass.



Figure 7. spreading out firestones



Figure 7.b Completed fireglass installation

### Installing Optional Speckled Stones

[RR\*\*\*SS]

The R324STIO Residential fireplace has the option of installing speckled stones. Place 115 stones in each outer tray and 250 stones in the middle tray. Place the stones at random with the numbered side of each stone facing down.

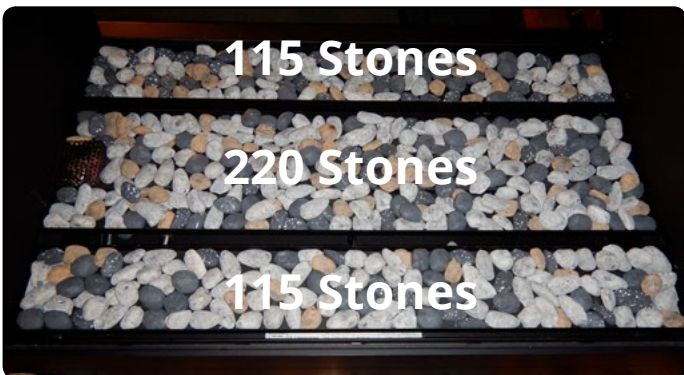

Figure 7.c Completed Speckled Stone installation

### Optional River Rocks

The C-View Residential fireplace has the option of installing the cultured rocks which mimic real stone. These may be spaced at random, or in a visual pattern of your preference without touching the flame. See the Montigo web site for photographs and ideas.

[www.montigo.com](http://www.montigo.com)



Figure 7.d pilot note



## Optional Log Set

The Fireplace has the option of installing a drift wood log set. Once the base media of fireglass, firestones, or speckled stones has been placed the log set can be installed. Ensure logs are securely placed and will not tip or fall.

Log kits used to create sequence shown: 2 LGS58



Figure 8.b LGS58

**STEP 1:** Remove the glass door as described in the previous section.

**STEP 2:** Ensure selected media is installed per instruction as per Figures 24 - 24b or 24.c.

**STEP 3:** Unpack the logs and handle with care.

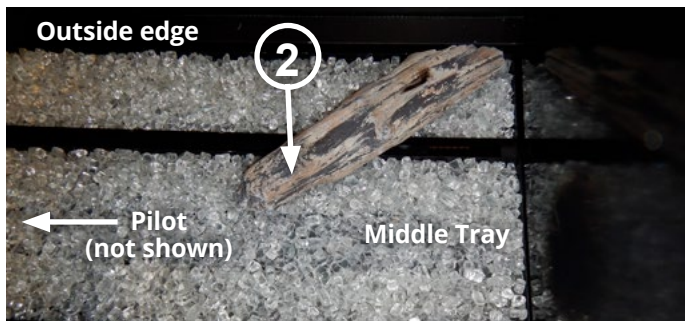

Figure 8.c

**STEP 4:** Starting from the outside edge of the fireplace, place the first log #2 diagonally across the middle and outside trays opposite to the pilot shield.

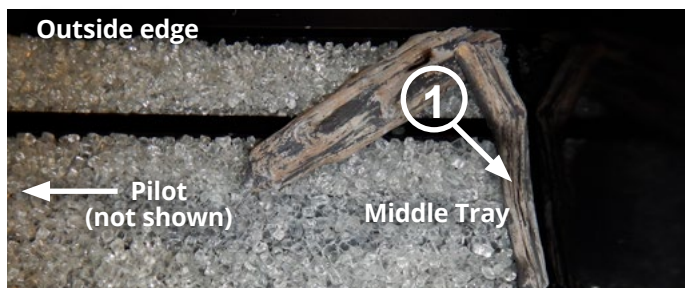

Figure 8.d

**STEP 5:** Place the first log #1 along the outer edge of the middle tray with one end resting on log #2 as shown in Figure 26.



Figure 8.e

**STEP 6:** Place the first log #6 along the inside tray opposite to the pilot shield shown in Figure 27.



Figure 8.f

**STEP 7:** Place the second log #2 along the inside tray resting on log #6, resting right beside the burner as shown in Figure 14.

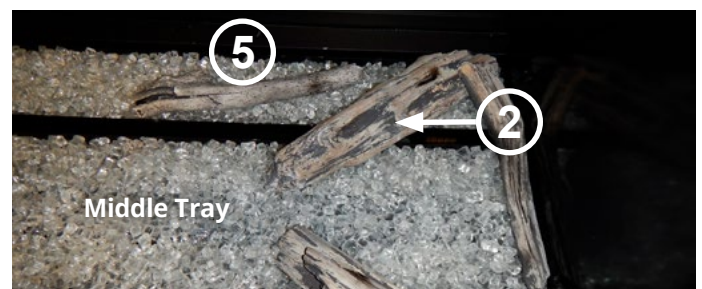

Figure 8.g

**STEP 8:** Place the first log #5 along the outer tray as shown.



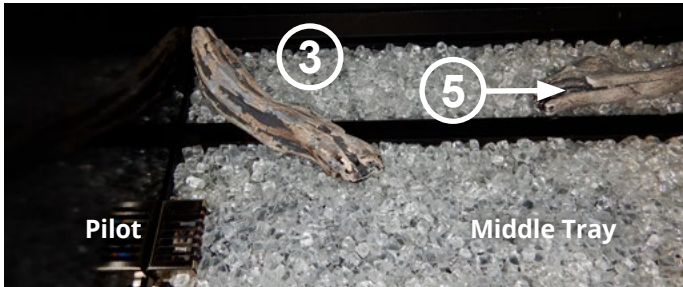

Figure 8.h

**STEP 9:** From the pilot side of the fireplace, align the first log #3 crossing from the inner tray to the middle as shown.



Figure 8.j

**STEP 12:** Place second log 5 next to burner on the middle tray as shown.

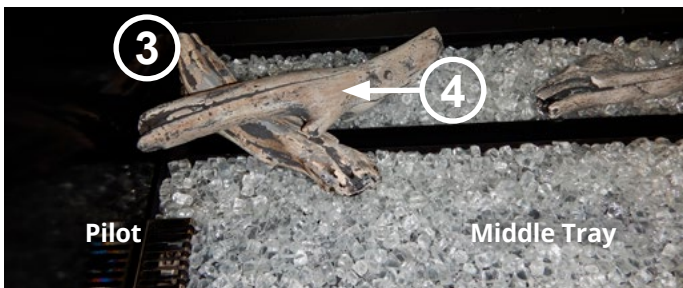

Figure 8.i

**STEP 10:** Place the second log #4 resting on log #3, crossing from the outer side of the fireplace to the middle tray as shown.



Figure 8.k

**STEP 13:** Place the second log #4 resting on log #5 crossing from the inner side of the fireplace to the middle tray as shown. Be sure the log does not block burner ports.



Figure 8.j

**STEP 11:** Place log F of LGS58 across log D from LGS58 and log 4 from LGS59, see figure 26g.

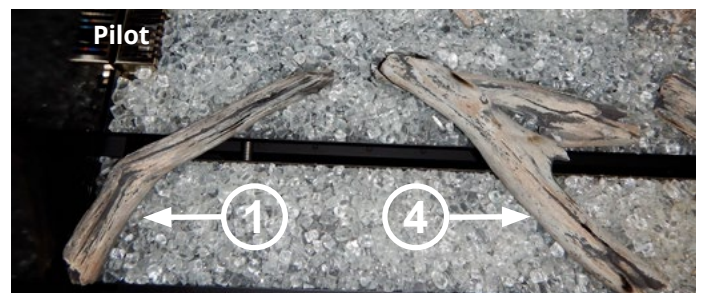

Figure 8.l

**STEP 14:** Place log F of LGS58 across log D from LGS58 and log 4 from LGS59, see figure 26g.

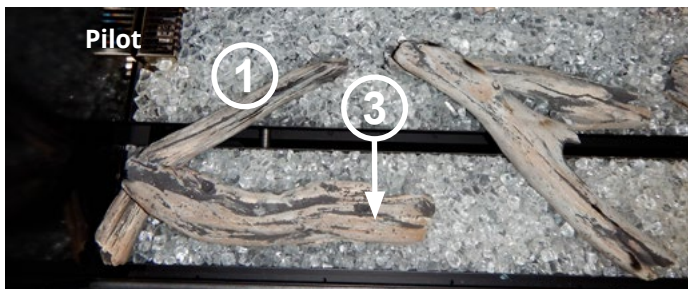

Figure 8.m

**STEP 15:** Place second log 5 next to burner on the middle tray as shown.

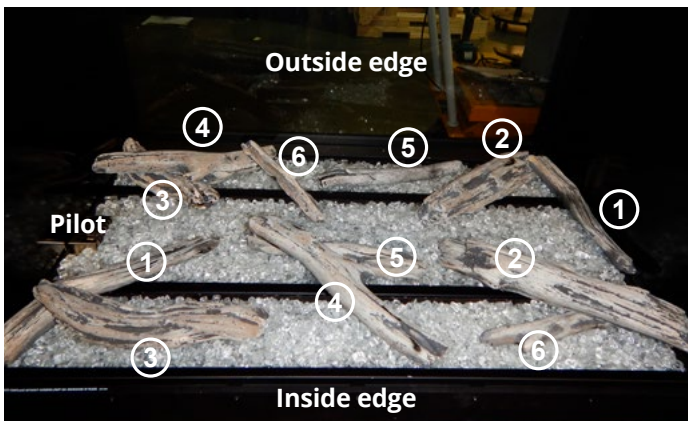

Figure 8.n

## FOR YOUR SAFETY - READ BEFORE LIGHTING:

## DANGER

**HOT GLASS WILL CAUSE BURNS.  
DO NOT TOUCH GLASS UNTIL COOLED.**

**NEVER ALLOW CHILDREN TO TOUCH GLASS.**

A barrier designed to reduce the risk of burns from the hot viewing glass is provided with this appliance and must be installed for the protection of children and other at-risk individuals.

**WARNING** If the information in these instructions are not followed exactly, a fire or explosion may result causing property damage, personal injury or death.

**WARNING / CAUTION: Hot while in operation. Do not touch. Severe burns may result. Keep children, clothing, furniture, gasoline and other liquids having flammable vapors away.**

**See installation and operating instructions accompanying this appliance.**

- |  |  |
|--|--|
| <p>A. This appliance has a pilot which is lit automatically. Do not attempt to light the pilot by hand.</p> <p>B. <b>BEFORE LIGHTING</b> smell all around the appliance area for gas. Be sure to smell next to the floor because some gas is heavier than air and will settle on the floor.</p> <p><b>What To Do If You Smell Gas:</b></p> <ul style="list-style-type: none"> <li>■ Do not try to light the appliance.</li> <li>■ Do not touch any electrical switch. Do not use any phone in your building.</li> <li>■ Immediately call your gas supplier from a neighbour's phone. Follow the gas suppliers instructions.</li> </ul> | <ul style="list-style-type: none"> <li>■ If you cannot reach your gas supplier, call the Fire Department.</li> </ul> <p>C. Use only your hand to push in or turn the gas control knob. Never use tools. If the knob will not push in or turn by hand, don't try to repair it. Call a qualified service technician. Force or attempt to repair may result in a fire or explosion.</p> <p>D. Do not use this appliance if any part has been under water. Immediately call a qualified service technician to inspect the appliance and to replace any part of the control system, and any gas control which has been under water.</p> |
|--|--|

## LIGHTING INSTRUCTIONS:

- |  |   |
|--|---|
| <ol style="list-style-type: none"> <li>1. <b>STOP!</b> Read the safety information above on this label.</li> <li>2. Turn the fireplace "OFF" using the wall switch or remote control.</li> <li>3. Wait 5 minutes to clear out any gas. If you smell gas, <b>STOP!</b> Follow "B" in the safety information above on this label. If you don't smell gas, go to the next step.</li> <li>4. Turn the fireplace "ON" using the wall switch or remote control.</li> </ol> | <ol style="list-style-type: none"> <li>5. The wall switch LED and heat sensor/combustion air LED will light up.</li> <li>6. Once the predetermined airflow is established in the firebox, the flue gas switch LED will light up after 30 seconds.</li> <li>7. After approximately 1 minute the hot surface igniter will start to glow. The pilot will light up, followed by the main burner. The fireplace will then start up.</li> </ol> |
|--|---|

**NOTE:** This unit is equipped with an ignition system that lights the pilot burner automatically. Do not attempt to light the pilot by hand.

This unit is equipped with advanced safety controls including pre and post purge timers. The fireplace will not turn on until all of the safety conditions are met. The fans in the fireplace may operate for an extended period of time even after the wall switch is turned off.

**NOTE:** If the igniter does not glow, even after 3 minutes have passed, follow the instructions "To Turn Off Gas To Appliance" and call your service technician or Montigo dealer.

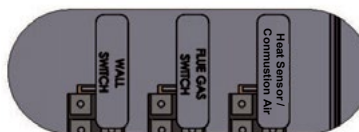

Control box LED lights

## TO TURN OFF GAS TO APPLIANCE:

- |  |  |
|--|--|
| <ol style="list-style-type: none"> <li>1. Turn the fireplace off using the wall switch or remote control.</li> <li>2. Turn off all electrical power to the appliance.</li> </ol> | <ol style="list-style-type: none"> <li>3. Locate the gas shut off valve for the appliance and turn off.</li> </ol> |
|--|--|

PIN LB1174-112614

## Section 8: Cleaning and Maintenance

### General

- Have the fireplace and installation inspected yearly. The inspection must include, but is not limited to, the following:
  - A visual check of the exhaust intake area for blockage.
  - An inspection of the door gasket to ensure a proper seal.
  - An inspection of the burner, media placement, and primary air openings.
  - An inspection of the gas valve, gas components, and pilot flame. Inspect for corrosion of firebox and other components.
  - Inspection of all optional equipment; fans, etc.
  - Confirm pre purge timer is set to one (1) minute.
- For Natural Gas this appliance requires a minimum inlet pressure of 5.5" W.C. and a manifold pressure of 3.5" W.C.
- For Propane Gas this appliance requires a minimum inlet pressure of 11" W.C. and a manifold pressure of 10" W.C.
- Always keep the fireplace area clear and free of combustible materials, as well as gasoline and other flammable vapors and liquids.
- Do not use this appliance if any part has been under water. Immediately call a qualified service technician to inspect the appliance and to replace any part of the control system and any gas control which has been under water.

### Cleaning

When the fireplace is first activated, there may be some smoke and a visible film may be left on the glass. This is a normal condition, and is the result of burning of protective coatings on new metal.

- Glass must be cleaned periodically to remove any film (which is a normal by-product of combustion) which may be visible. Film can easily be removed by removing the door. Handle the door carefully, and clean it with non-abrasive glass cleaners. One of the most effective products is Kel Kem.
- Use a vacuum cleaner or whisk broom to keep the control compartment, exhaust area and firebox free from dust and lint.

### Procedure for resetting Temperature Limit Switch

Temperature limit switch may trip if exhaust is blocked by snow, dirt, debris, etc. The following steps will enable you to reset the Temperature limit switch.

1. Ensure wall switch is 'OFF'.
2. Clear blockage (snow, dirt, debris, etc) in front of exhaust.
3. Open exhaust grill
4. With a small screw driver push red pin to reset switch.
5. Replace grill
6. Turn on fireplace

### NOTICE

Do not use ammonia or abrasive cleaners on the glass, they will permanently etch the surface. Use an approved gas fireplace cleaner such as Kel-Kem or White off.

### Annual inspection list for determining safe operation of a direct vent gas fireplace

- 1) Inspect and operate the pressure relief mechanism to verify relief mechanisms are free from obstruction to operate.
- 2) Clean glass window with a suitable fireplace glass cleaner. Abrasive cleaners must not be used. Be careful not to scratch the glass when cleaning.
- 3) Inspect the operation of the flame safety system Pilot or Flame rectification device.
- 4) Inspect and ensure the lighting of the main burner occurs within 4 seconds of the main gas valve opening. Visual inspection should match that outlined in the appliance instruction manual. Inspect primary air openings for blockage.
- 5) Inspect condition of vent and vent terminal for sooting or obstruction and correct if present.
- 6) Vacuum and clean any debris in the firebox that is not supposed to be there.
- 7) Test and measure the flame failure response time of the flame safety system. It must de-energize the safety shutoff in no more than 30 seconds.
- 8) Check all accessible gas-carrying tubes, connections, pipes and other components for leaks.

### Pilot burner adjustment

1. Turn off gas
2. Remove indoor glass and burner tray so that air switch LED is visible.
3. Turn wall switch 'ON'.
4. Reduce the fan speed by turning speed dial clockwise. Ensure LED (R3) turns off when fan is turned off.

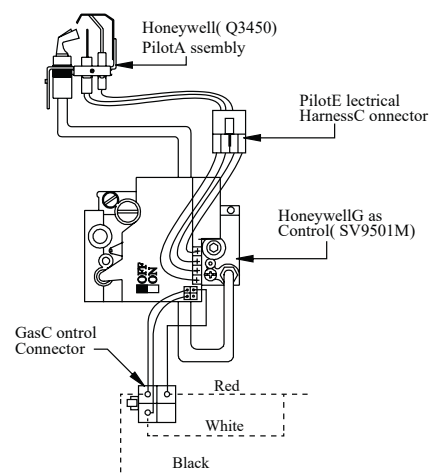



## Appendix B: Warranty

### MONTIGO RESIDENTIAL WARRANTY PROGRAM

Canadian Heating Products Inc. and/or Montigo DelRay Corp (collectively referred to herein as "The Companies"), warrants the Montigo gas appliance (referred to herein as 'the appliance') to be free from defects in materials and workmanship at the time of manufacture. The gas appliance and related components are further subject to the terms and conditions set forth below.

This warranty covers the following Montigo product series: **Distinction, Divine & Divine Outdoor (H-Series), Illume (FID Inserts), Phenom (L/P/PL-Series), Exemplar (R/RP-Series), Mahana and DelRay**

| Component  | Coverage Period | Labor Coverage |
|--|-----------------|----------------|
| Firebox, heat exchanger  | 15 years        | 1 year         |
| Main burner  | 15 years        | 1 year         |
| Gas control valve and related control components (pilot assembly, spark electrode flame sensors, thermopile)                                     | 1 year          | 1 year         |
| Electrical components (internal blowers, ignition control module, wiring, switches, remote control systems, blower control module, accent bulbs) | 1 year          | 1 year         |
| Firebox media (logset, glass beads, river rocks)   | 1 year          | 1 year         |
| Glass (thermal breakage)   | 1 year          | 1 year         |
| Plated, painted finishes (including interior reflective glass) *   | 1 year          | 1 year         |
| Refractory lining  | 1 year          | 1 year         |
| Mesh/Glass safety barriers   | 1 year          | 1 year         |
| Power vent termination   | 1 year          | 1 year         |
| Montigo terminations*  | 10 years        | 1 year         |
| Montigo venting (excluding termination)  | 15 years        | 1 year         |

\* *Exterior painted surfaces exempt*

### QUALIFICATIONS TO THE WARRANTY

This Warranty only covers gas appliances installed in the United States or Canada.

To receive the benefits of this warranty, the appliance must be purchased, installed and serviced annually by a dealer authorized by The Companies for the warranty to be valid.

The gas appliance must be installed by a licensed professional in accordance with The Companies' installation instructions and local building codes. The warranty on the appliance covers only components manufactured by The Companies. The use of components manufactured or supplied by other manufacturers and used in conjunction with the appliance could create serious safety hazards, may result in the denial of certification by recognized national safety agencies and could violate local building codes. Such use may untimely void this warranty. This warranty does not cover any damages occurring from the use of any components not manufactured or supplied by The Companies.

The appliance must be subjected to normal use. The appliance is designed to burn natural gas (NG) or liquefied petroleum (LP) only. Burning conventional fireplace fuels such as wood, coal or any other solid fuel will cause damage to the appliance, produce

excessive temperatures will result in a fire hazard and void all warranties. This warranty is transferable. The appliance must remain in its original place of installation to be valid.

If the components of the appliance covered by this warranty are found to be defective within the time frame stated (see The Companies investigation of claims), The Companies will, at its option, replace or repair defective components of the appliance manufactured by The Companies at no charge and will also pay for labor costs (in accordance with schedule) incurred in replacing or repairing components. If repair or replacement is not commercially practical, The Companies will, at its sole discretion, fully discharge all obligations under the warranty by refunding the verified dealer purchase price of the appliance, excluding the cost of labor unless the labor is covered by the terms of the warranty.

This warranty covers only parts and labor as provided above. In no case shall the companies be responsible for materials, components or construction, which are not manufactured or supplied by The Companies, or for the labor necessary to install, repair or remove such materials, components or construction. All replacement or repair components will be shipped F.O.B. from the nearest Company factory.

### LIMITATION ON LIABILITY

It is agreed and understood that The Companies sole obligation, and purchaser's exclusive remedy under this warranty, under any other warranty, expressed or implied, or in contract, tort or otherwise, shall be limited to repair, replacement or refund as specified above. The opinion of The Companies with respect to these matters shall be final.

In no event shall The Companies be responsible for any incidental or consequential damages caused by (but not limited to) improper installation, installation by an unqualified or unauthorized installer, accident, lack of regular maintenance, user error, abuse, misuse, Acts of God, power surges, floods, natural disasters, force majeure, defects in its appliance whether such damage occurs or is discovered before or after replacement or repair, and whether or not such damage is caused by The Companies negligence. Some jurisdictions do not allow the exclusion or limitation of incidental or consequential damages, so the above limitation or exclusion may not apply to you. The duration of any implied warranty with respect to the appliance is limited to the duration of the foregoing warranty. Some jurisdictions do not allow limitations on how long an implied warranty lasts, so the above limitation or exclusion may not apply to you.

## Appendix B: Warranty Continued

### EXCLUSIONS TO WARRANTY

Corrosion or rust of any kind due to a lack of maintenance, inadequate combustion air or improper venting and corrosive chemicals/environments, expansion and contraction of metals or minor movements of components causing noise are not covered by this warranty.

Willful misconduct (i.e. use of the appliance with problems known to the purchaser and causing further damages), including unauthorized or self-performed 'fixing' or exploration of the appliance's internal workings will void the warranty.

Appliances on which the serial number has been altered, defaced, removed or made illegible will void the warranty.

Costs incurred for diagnosis, service work, shipping and handling of defective or replacement parts are not covered under this warranty.

The published warranties are not applicable for any equipment manufactured by The Companies that has been sold direct to the consumer via internet or auction websites. The Companies do not endorse, approve or certify any online sale of its products through auction websites, online retailers or any other method of online sales direct to consumers.

### INVESTIGATION OF CLAIMS AGAINST WARRANTY

The Companies reserve the right to investigate any and all claims against this warranty and decide upon method of settlement.

The Companies are not responsible for work done without written consent of The Companies.

The Companies shall in no event be responsible for any warranty work done without first obtaining the Companies written consent.

The Companies employees and dealers have no authority to make any warranties to neither alter this warranty nor authorize any remedies in addition to or inconsistent with those stated within this warranty.

### IF WARRANTY SERVICE IS NEEDED

To make a claim under this warranty, contact your installing dealer or contractor. The installing dealer is responsible for providing service and will contact the companies to initiate warranted parts replacements. In the event the installing dealer is unavailable, contact your nearest authorized Montigo dealer ([www.Montigo.com](http://www.Montigo.com)) or contact Montigo direct at [techsupport@montigo.com](mailto:techsupport@montigo.com). Ensure you have your sales receipt and the model and serial number of your appliance.

### DO NOT ATTEMPT TO DO ANY SERVICE WORK YOURSELF

If you cannot locate the installing dealer, or nearest dealer/distributor, you must notify The Companies in writing.

### USA Offices

6955 Salashan Parkway  
Ferndale WA, 98248  
[techsupport@montigo.com](mailto:techsupport@montigo.com)

### Canadian Offices

27342 Gloucester Way  
Langley, BC V4W 4A1  
[techsupport@montigo.com](mailto:techsupport@montigo.com)

The terms and conditions of this warranty may be altered or amended from time to time without prior notice.

**WARRANTY PERIOD:** Warranty coverage begins on the date of original purchase. In the case of new construction, warranty coverage begins on the date of first occupancy of the dwelling or six months after the sale of the product by an independent, authorized Company dealer/ distributor, whichever occurs earlier.

## Appendix B: Amendment (Gas Fireplace / Equipment sold in the State of Massachusetts)

### 5.08: Modifications to NFPA-54, Chapter 10

- (1) Revise NFPA-54 section 10.5.4.2 by adding a second exception as follows:

Existing chimneys shall be permitted to have their use continued when a gas conversion burner is installed, and shall be equipped with a manually reset device that will automatically shut off the gas to the burner in the event of a sustained back-draft.

- (2) Revise 10.8.3 by adding the following additional requirements:

(a) For all side wall horizontally vented gas fueled equipment installed in every dwelling, building or structure used in whole or in part for residential purposes, including those owned or operated by the Commonwealth and where the side wall exhaust vent termination is less than seven (7) feet above finished grade in the area of the venting, including but not limited to decks and porches, the following requirements shall be satisfied:

1. **INSTALLATION OF CARBON MONOXIDE DETECTORS.** At the time of installation of the side wall horizontal vented gas fueled equipment, the installing plumber or gas fitter shall observe that a hard wired carbon monoxide detector with an alarm and battery back-up is installed on the floor level where the gas equipment is to be installed. In addition, the installing plumber or gas fitter shall observe that a battery operated or hard wired carbon monoxide detector with an alarm is installed on each additional level of the dwelling, building or structure served by the side wall horizontal vented gas fueled equipment. It shall be the responsibility of the property owner to secure the services of qualified licensed professionals for the installation of hard wired carbon monoxide detectors
  - a. In the event that the side wall horizontally vented gas fueled equipment is installed in a crawl space or an attic, the hard wired carbon monoxide detector with alarm and battery back-up may be installed on the next adjacent floor level.
  - b. In the event that the requirements of this subdivision can not be met at the time of completion of installation, the owner shall have a period of thirty (30) days to comply with the above requirements; provided, however, that during said thirty (30) day period, a battery operated carbon monoxide detector with an alarm shall be installed.
2. **APPROVED CARBON MONOXIDE DETECTORS.** Each carbon monoxide detector as required in accordance with the above provisions shall comply with NFPA 720 and be ANSI/UL 2042 listed and IAS certified.
3. **SIGNAGE.** A metal or plastic identification plate shall be permanently mounted to the exterior of the building at a minimum height of eight (8) feet above grade directly in line with the exhaust vent terminal for the horizontally vented gas fueled heating appliance or equipment. The sign shall read, in print size no less than one-half (1/2) inch in size, "GAS VENT DIRECTLY BELOW. KEEP CLEAR OF ALL OBSTRUCTIONS".

4. **INSPECTION.** The state or local gas inspector of the side wall horizontally vented gas fueled equipment shall not approve the installation unless, upon inspection, the inspector observes carbon monoxide detectors and signage installed in accordance with the provisions of 248 CMR 5.08(2)(a)1 through 4.

(b) **EXEMPTIONS:** The following equipment is exempt from 248 CMR 5.08(2)(a)1 through 4:

1. The equipment listed in Chapter 10 entitled "Equipment Not Required To Be Vented" in the most current edition of NFPA 54 as adopted by the Board; and
2. Product Approved side wall horizontally vented gas fueled equipment installed in a room or structure separate from the dwelling, building or structure used in whole or in part for residential purposes.

(c) **MANUFACTURER REQUIREMENTS - GAS EQUIPMENT VENTING SYSTEM PROVIDED.** When the manufacturer of Product Approved side wall horizontally vented gas equipment provides a venting system design or venting system components with the equipment, the instructions provided by the manufacturer for installation of the equipment and the venting system shall include:

1. Detailed instructions for the installation of the venting system design or the venting system components; and
2. A complete parts list for the venting system design or venting system.

(d) **MANUFACTURER REQUIREMENTS - GAS EQUIPMENT VENTING SYSTEM NOT PROVIDED.** When the manufacturer of a Product Approved side wall horizontally vented gas fueled equipment does not provide the parts for venting the flue gases, but identifies "special venting systems", the following requirements shall be satisfied by the manufacturer:

1. The referenced "special venting system" instructions shall be included with the appliance or equipment installation instructions; and
2. The "special venting systems" shall be Product Approved by the Board, and the instructions for that system shall include a parts list and detailed installation instructions.

(e) A copy of all installation instructions for all Product Approved side wall horizontally vented gas fueled equipment, all venting instructions, all parts lists for venting instructions, and/or all venting design instructions shall remain with the appliance or equipment at the completion of the installation.

- (3) After NFPA-54 section 10.10.4.2 add a new section 10.10.4.3 as follows:

When more than four gas appliances are to be vented through a common gas vent or common horizontal vent manifold, a plan of the proposed vent installation shall be submitted to the Inspector and the serving gas supplier for review and approval.

Extraction from: Massachusetts Rules and Regulations

5.00: Amendments To 2002 Edition Of ANSI Z223.1-NFPA-54

## Appendix C: Canadian Installation Notice

### Canadian Installations

Canadian installations require 18" of non-combustible hearth in front of the unit and 6" below the unit. Please contact your Montigo dealer for the Canadian edition of the installation and maintenance manual or for any further information.

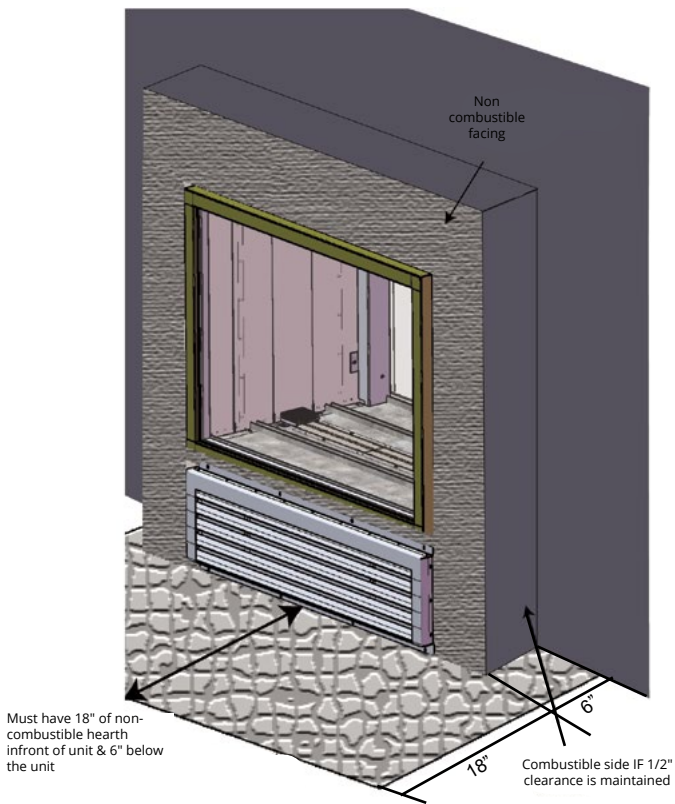





**R324STIO**  
**INDOOR/OUTDOOR**  
**GAS FIREPLACE**