

! **EXAMPLE CONFIGURATION ONLY**
 This fireplace model is highly customizable. Refer to model specifications for minimum and maximum allowable dimensions.

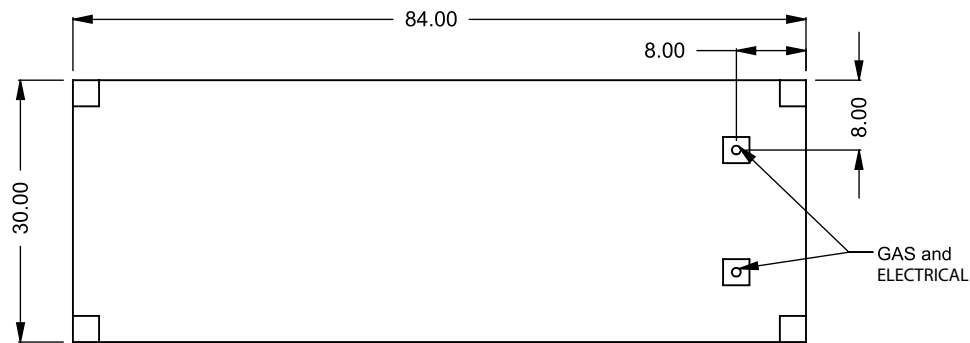
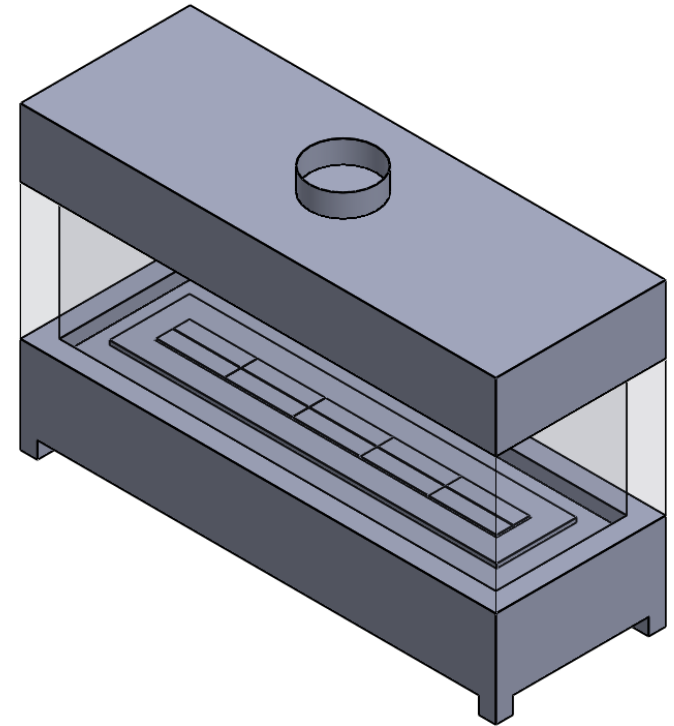
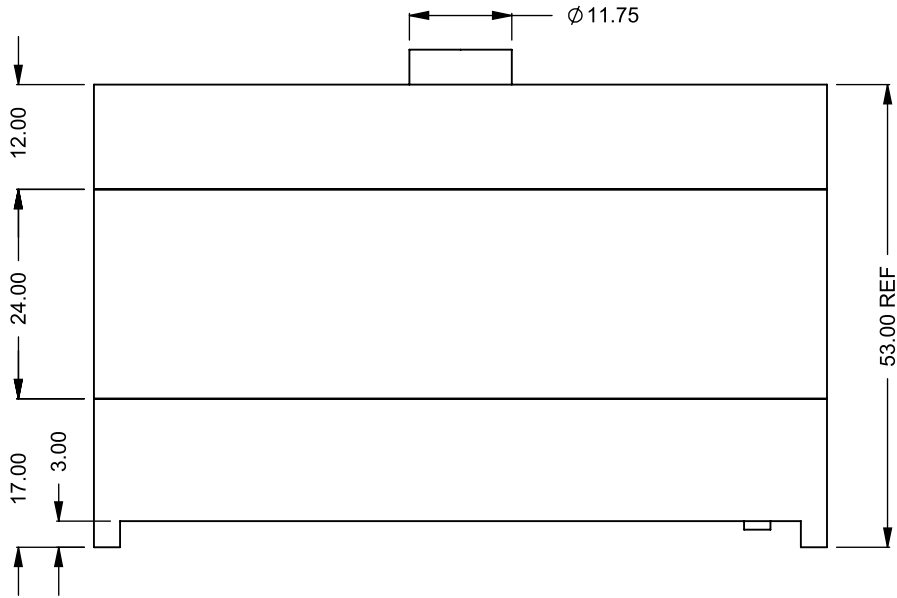

C4W7
 84x30x24
 Passive Intake Bottom

PRELIMINARY DRAWING	UNLESS OTHERWISE SPECIFIED	DATE
<p>C4W SERIES UNITS ARE CUSTOM BUILT FOR EACH PROJECT. THIS DRAWING IS FOR REFERENCE ONLY.</p> <p>FLUE AND AIR INTAKE SIZES ARE SUBJECT TO CHANGE DEPENDING ON VENT RUN.</p>	<p>DIMENSIONS ARE IN INCHES TOLERANCES: FRACTIONAL $\pm 1/32"$ TWO PLACE DECIMAL $\pm .015"$ THREE PLACE DECIMAL $\pm .005"$ TO BE 90° UNLESS NOTED OTHERWISE</p>	<p>12/04/2016</p>
<p>MONTIGO the art of fireplaces www.montigo.com</p>		