

TECHNICAL SPECIFICATION

This Montigo commercial fireplace and its associated components are part of a custom engineered system.

This system is available with COOL-Pack or Power COOL-Pack cool-touch glass technology, which is ideal for public use applications and residential common or entertaining areas. All systems are power vented with multiple options available and are tested and certified to current ANSI Standards with CSA International US and Canada.

All Montigo commercial fireplace systems are highly customizable. Please contact Montigo to confirm if your installation requirements are within the parameters of these standard specifications.

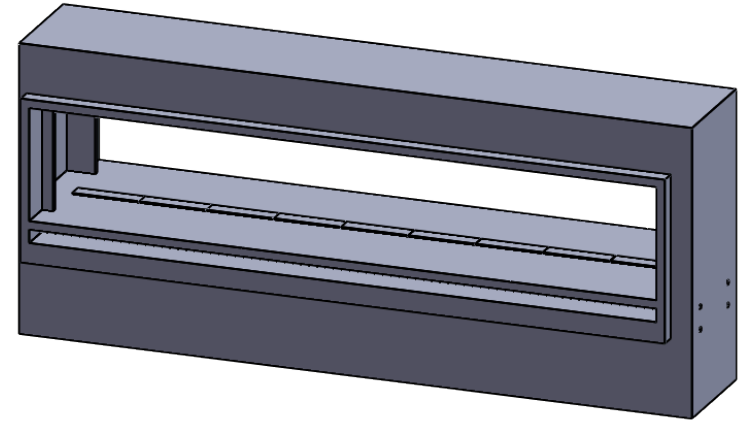

GLASS **GLASS DIMENSIONS CAN BE CUSTOMIZED**

Glass Width: 108"

Glass Height: 20"

Glass Type: 5 mm or 6 mm thick tempered glass (standard)

8 mm tempered glass available (optional)

Laminated safety glass standard on units > 96" tall

No Glass: Open units are available

GLASS TEMPERATURE

COOL-Pack < 172°F†

Power COOL-Pack Up to a 60°F reduction†

TYPICAL INTAKE

Intake Location: Front, below glass

Intake Damper: Optional, tied into control system

TYPICAL EXHAUST

Power Vent: Integrally built into the system

GAS

Rating Input: Estimated 145,000 BTU/hr

Minimum Inlet Pressure: 5.5" w.c. Natural Gas / 11" w.c. Propane

Gas System: ½" NPT, Hot Surface Ignition, Smart Valve

Concealed Burner with 8" ribbon flame or 16" high-low flame

CONSTRUCTION

Full stainless steel

ELECTRICAL

Standalone custom control panel mounted within 150' of fireplace, 208-240 VAC w Neutral, AMP rating depends on actual spec

BURNER MEDIA

Glass media. Optional: Driftwood logs, speckled stones

OPTIONS

Uplighting, downlighting, lighting remote control, black reflective glass, privacy glass

TESTING STANDARDS

ANSI Z21.50/ CSA 2.22-2016, ANSI Z21.97/ CSA 2.41-2017

† Actual glass temperature will vary based on BTU, vent run configuration, fireplace size, utilized media and panels, ambient temperature and other factors

MONTIGO® Finishing a Commercial Fireplace Throated Framing

Montigo Commercial Terminology



Throated Fireplace - A "throat" that extends outside the fireplace to aid in framing and finishing.



Flush Fireplace - Unit body is flush from the opening to the rest of the fireplace.



BF Fireplace - Referring to a fireplace with a logset (Refer to rating plate as well.)



C-View Fireplace - Referring to a fireplace with a glass or stone media bed (Refer to rating plate as well.)

Throated Single Sided Framing

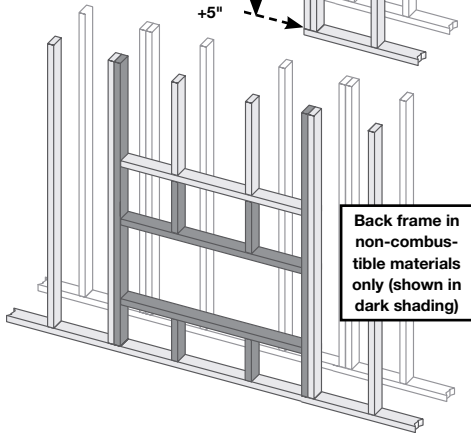
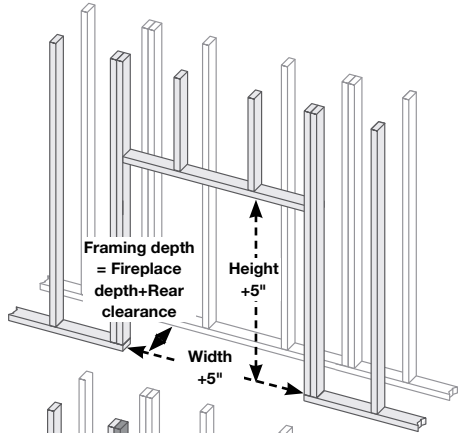

Throated See Through Framing

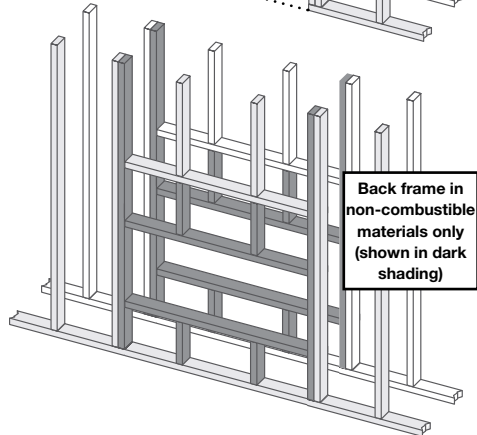
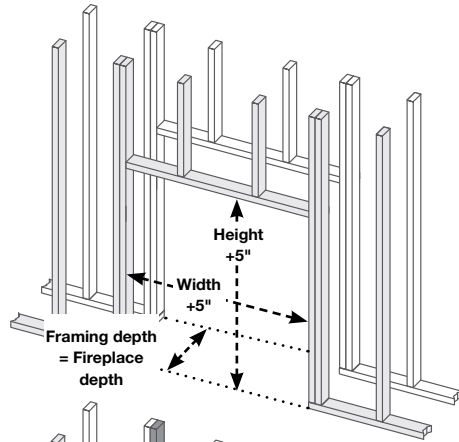

Throated Bay Framing

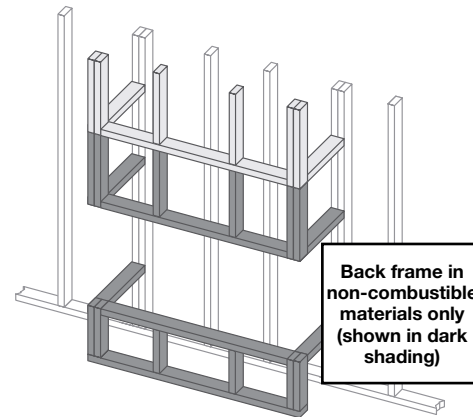
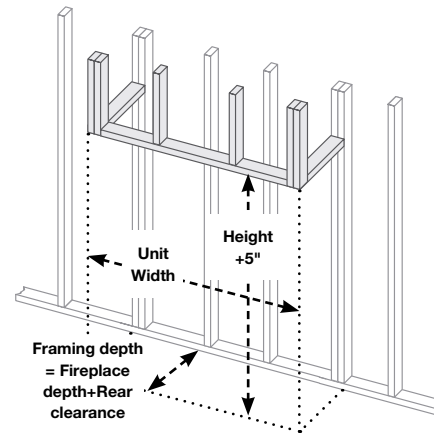

BF Fireplace - Clearance to combustibles					
Top	Rear	Sides	Floor	Mantel†	Glass
24"	3"	3"	0"	0"	1/8"

C-View Fireplace - Clearance to combustibles					
Top	Rear	Sides	Floor	Mantel†	Glass
24"	2"	2"	0"	0"	1/8"

STIO Fireplace - Clearance to combustibles					
Top	Rear	Sides	Floor	Mantel	Glass
3"	1"	1"	0"	12"	1/8"

† There are no restrictions on mantel clearance providing they do not project beyond the facing material edge, and the weight of the mantel is fully supported by the framing. Combustible mantels must not be in direct contact with fireplace. i.e. A mantel must have a noncombustible underlay between the fireplace and mantel.

STIO / ODD

This guide applies to the following configurations:
STIO / ODD

PROUD FINISH

This unit is designed to be installed on an exterior wall, or entirely outdoors. The air intake channel at the base of the exterior window must not be obstructed.

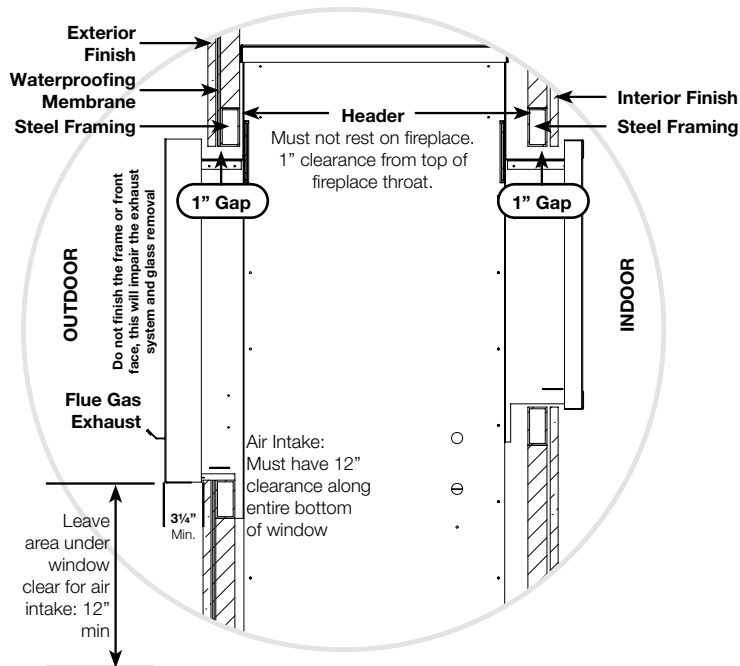

FLUSH FINISHING

This unit is designed to be installed on an exterior wall, or entirely outdoors. The air intake channel at the base of the exterior window must not be obstructed.

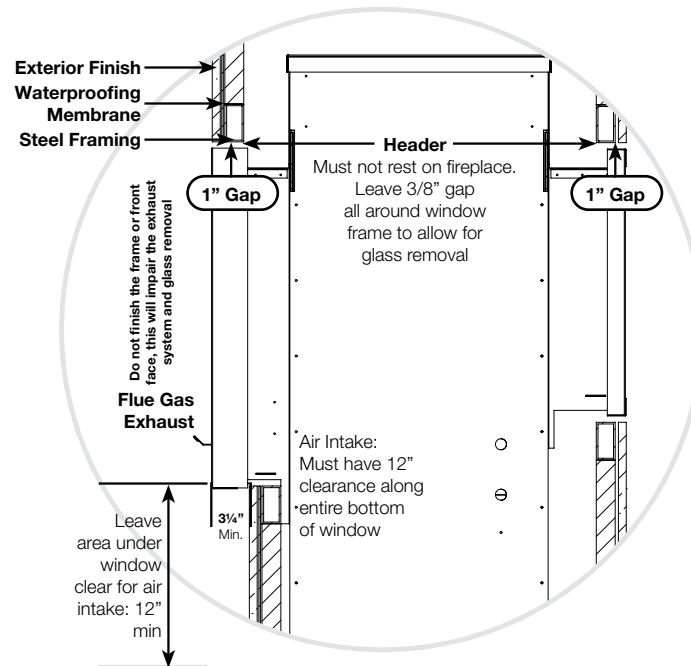

FLUE GAS EXHAUST TEMPERATURES

Flue gas exhaust and vent area are hot, temperatures of 200F-220F can be expected.

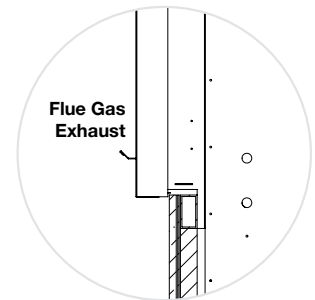

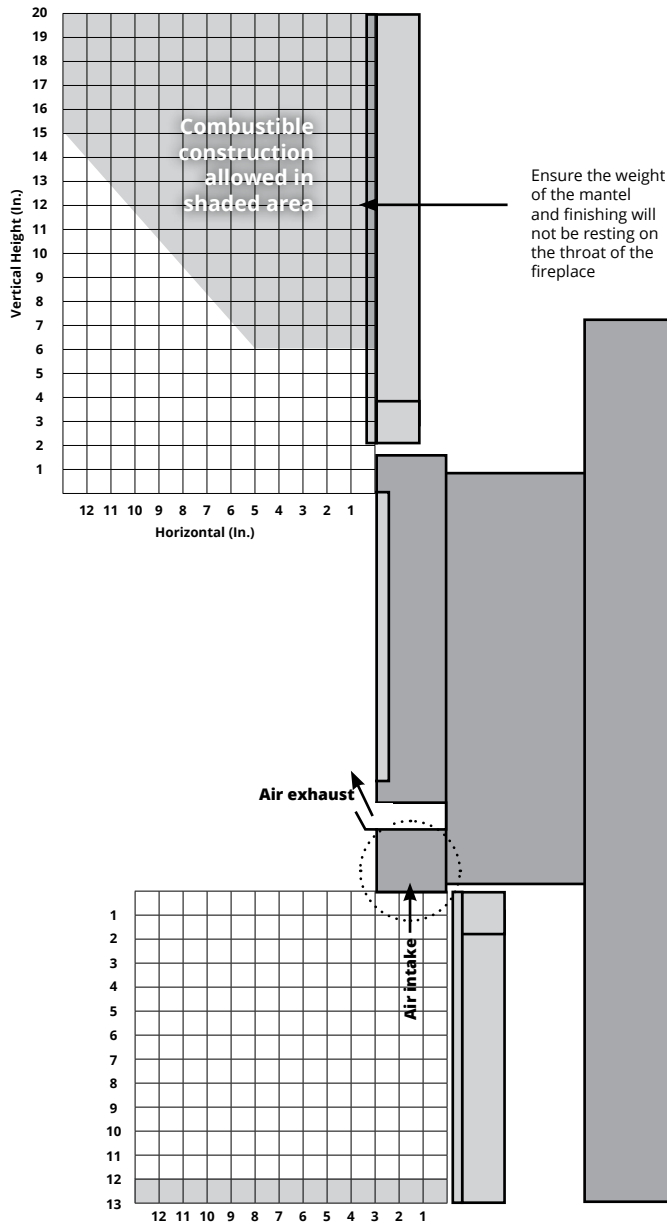

HEARTH'S
Due to the air intake channel, no hearths, combustible or otherwise, are permitted within 12" of the frame edge.

STIO / ODD

MANTELS AND SURROUNDS

Combustible mantels may safely be installed over the fireplace provided that they do not project beyond the shaded area shown.

There are no restrictions on Non-combustible mantels providing they do not project beyond the facing material edge and interfere with glass removal, and the weight of the mantel is fully supported by the framing.

IR Thermometer Testing

REQUIRED PROCEDURE

As each custom fireplace can experience different surface temperatures based on factors that can arise in the field (vent run, enclosure size), Montigo requires the testing of surface temperatures using an IR gun after running the fireplace for 2+ hours.

If temperatures are within reason, the IR testing should be repeated once the fireplace is framed and finished to confirm temperatures are OK. **NOTE:** A high surface temperature is not necessarily a call for concern as certain areas of the fireplace may be hot, but will not be in contact with a combustible when using our framing/finishing procedures.

STANDARD BUILD IS FULL STAINLESS STEEL CONSTRUCTION.
PLEASE INQUIRE FOR CUSTOM OPTIONS TO INCLUDE BLACK GALVANNEALED STEEL PARTS OR AREAS.

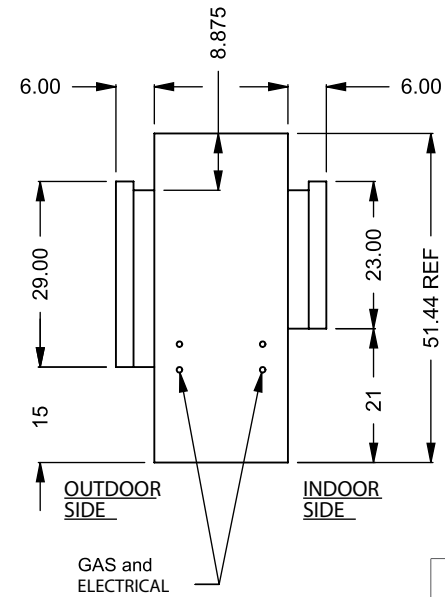
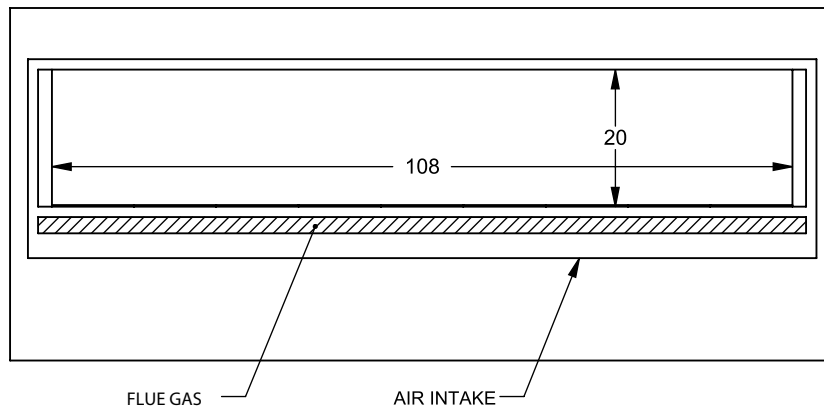
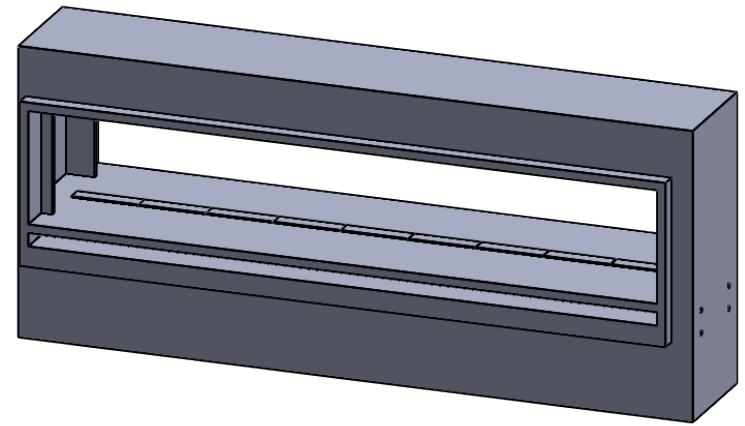
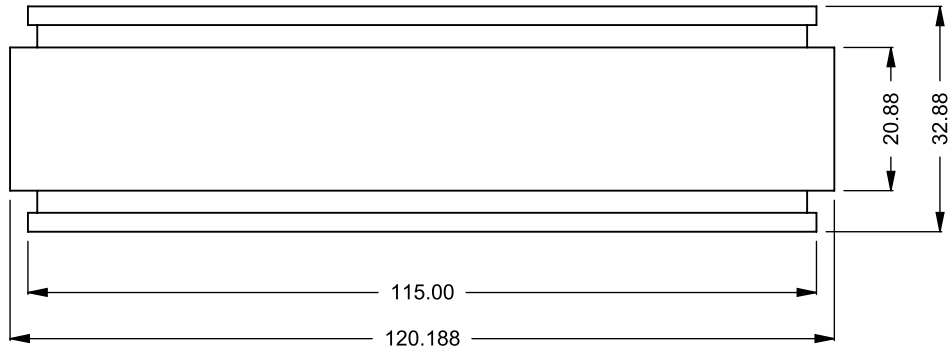

C920STIO
Power COOL-Pack
Front Intake

**PRELIMINARY
DRAWING ONLY** 

EXAMPLE CONFIGURATION	UNLESS OTHERWISE SPECIFIED	DATE
<p>MONTIGO COMMERCIAL FIREPLACES ARE CUSTOM BUILT FOR EACH PROJECT. THIS DRAWING IS FOR REFERENCE ONLY.</p> <p>FLUE AND AIR INTAKE SIZES ARE SUBJECT TO CHANGE DEPENDING ON VENT RUN.</p>	<p>DIMENSIONS ARE IN INCHES TOLERANCES: FRACTIONAL $\pm 1/8"$</p>	<p>15/10/2020</p>

MONTIGO
the art of **fireplaces**
www.montigo.com