

MONTIGO®

Installing the RFK3002/3004 Fan Kit

Optional Fans

for use with:

B34 DV2; B34 DV2-F

B38 DV2; B38 DV2-F

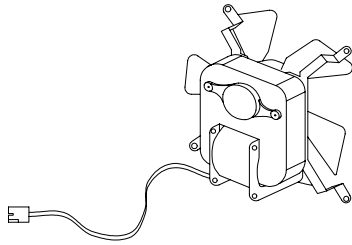

CAUTION

Ensure that all power to the appliance is off at the electrical breaker or fuse before beginning installation. Ensure gas is turned off at the shutoff valve before beginning installation.



- This kit should be installed by a qualified person.
- Check local codes and read all instructions prior to installation.



WARNING

When installing the fireplace - gas lines, fittings, accessories or any other objects cannot impede the proper movement of the door buckles.

General Information

This blower kit is for installation with the models listed above.

KIT #	Contents
RFK3002	2 fans, 1 PPO box, 1 wire harness (PCH2), speed controller (DRB001), 10 screws (HW2054), heat-activated control and speed control
RFK3004	4 fans, 1 PPO box, 1 wire harness (PCH4), speed controller (DRB001), 20 screws (HW2054), heat-activated control and speed control

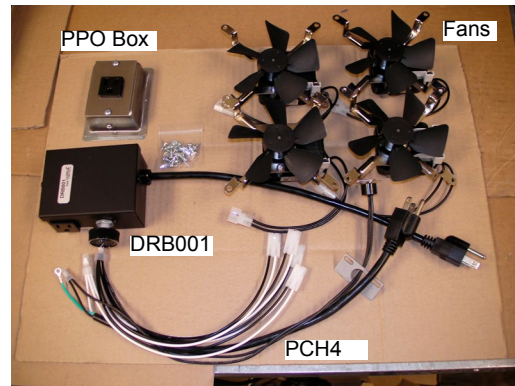

Figure 2 Kit contents (RFK3004).

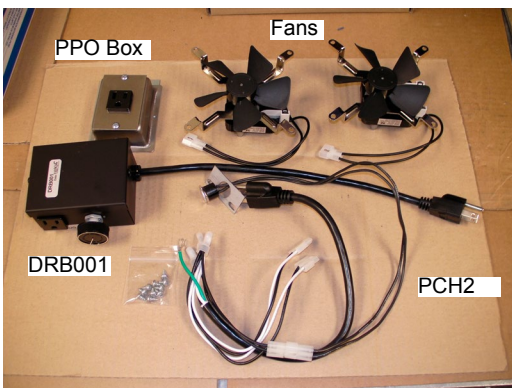

Figure 1 Kit contents (RFK3002).

Before You Begin

- Please read all instructions carefully
- We strongly recommend that all electrical service work be performed by a qualified electrical contractor.
- Check to ensure that all components required for installation are included in your package.



Installation

Installation

1. Accessing the Control Compartment

- Flip down the lower horizontal trims of the fireplace **Figure 3.**)

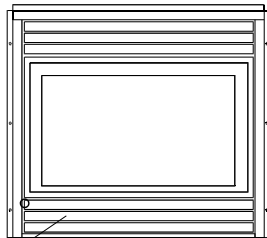

Lower horizontal trim

Figure 3 Accessing control compartment.

2. Fan Motor Installation

- Install each fan motor with the blades facing the 4" round fan opening. Attach the mounting legs by screwing into the pilot holes around the fan opening. Spin the fan blades by hand to ensure they don't hit the fan opening. (See **Figure 4.**)

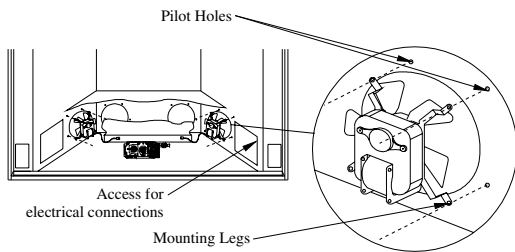

Figure 4 Cutaway view of control compartment showing fan motor installation.

3. Installing the Power Box (only for B34DV2, B38DV2)

- The PPO box connects the fans to the household electrical supply. In some models this box has been factory-installed, and is located at the bottom right corner of the fireplace.
- If the PPO box has not been factory installed, ensure that the household electrical supply is shutoff at the breaker or fuse, and connect the two wire leads from the box to the household electrical supply. Insert the PPO box into the square hole in the right-hand side of the control compartment and screw into place using self drilling hex screws as shown in **Figure 5, 6 and 7.**

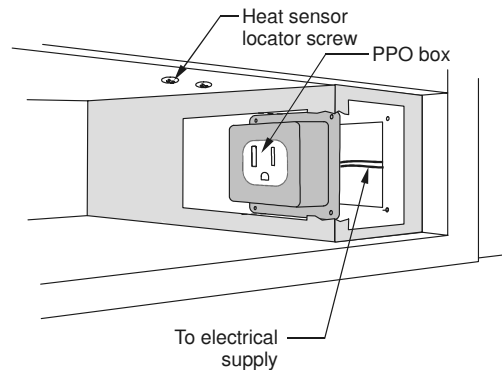

Figure 5 Installing the PPO Box.

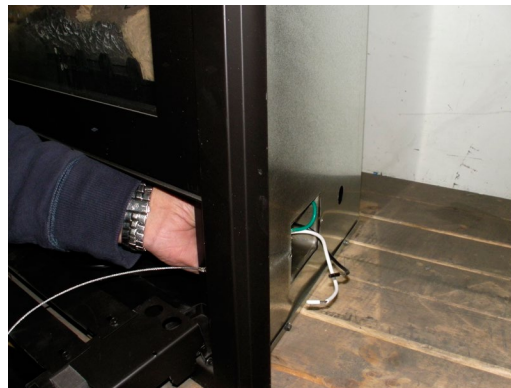

Figure 6 Installing the PPO Box (from outside of fireplace).

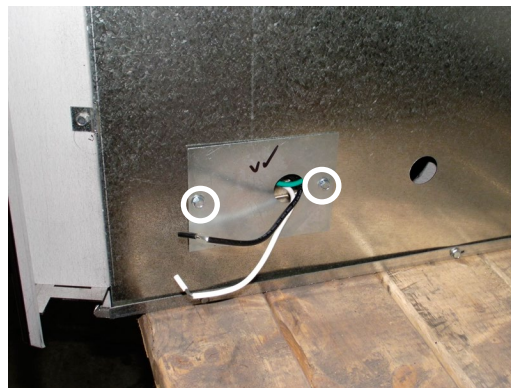

Figure 7 Lead wires that connect to household electrical supply.



Figure 8 Attaching power cord to PPO Box.

4. Attaching the Heat Sensor

- This kit includes a heat sensor for automatic control of the fans. Mount the sensor on the bottom right side of burner panbase. Remove the two screws located on the top of the control compartment, just to the right of the gas control valve. Attach the heat sensor by screwing the mounting bracket into place using the two screws.

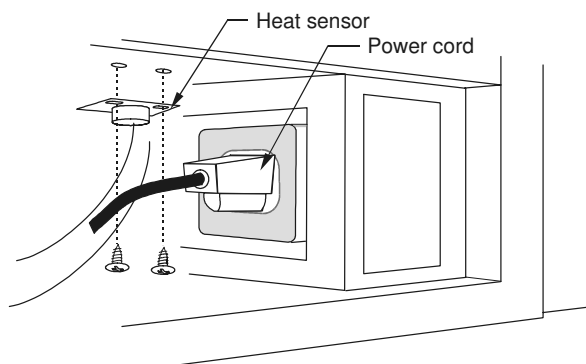

Figure 9 Installing the dual receptacle fan speed control box (DRB001).

5. Electrical Connections

- Plug each of the fan motor connectors into a quick connector on the wire harness.

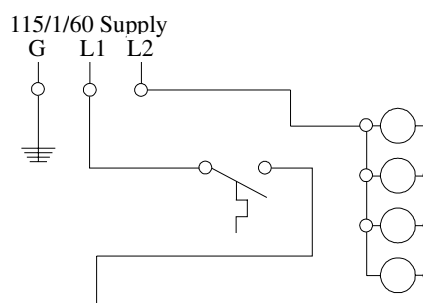
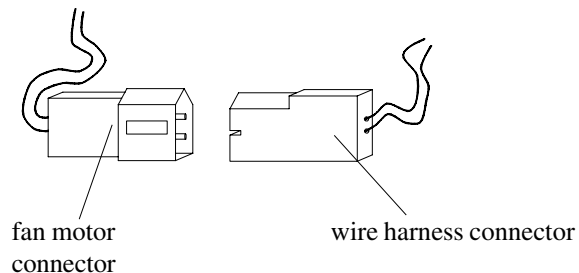

Figure 10 Electrical Connections.

6. Installing DRB001

- Attach DRB001 Power Cord to PPO box.
- Attach DRB001 to fireplace floor close to PPO box, and secure to bottom of shell using supplied velcro.
- Attach PCH 2/4 Power Cord to DRB001 Fan Plug.
- For B34 DV2-F and B38 DV2-F models, attach control box Power Cord to DRB001 (120V out plug).

7. Operation

- Turn on electrical power at the breaker or fuse.
- Turn on the fan speed controller DRB001 (See **Figure 8**).
- The fans will automatically switch after the fireplace's main burner has been lit and the temperature has risen. The time lapse between lighting the fireplace and fan activation will vary, depending on the model. The fans will automatically shut off as the fireplace cools.
- Adjust the fan speed using the knob on DRB001.



Installation

Wiring for the *optional Fan Kit*

All **B-Series DV-2** fireplaces may be equipped with optional fan kits for circulating heat into the living space.

Installations in Canada which employ the fans must be electrically grounded in accordance with **CSA C22.1** Canadian Electrical Code Part 1 and/or Local Codes.

Installations in the USA which employ the fans must be grounded in accordance with local codes or, in the absence of local codes, with the National Electrical Code, **ANSI/NFPA 70-1987**.

NOTE: If any of the original wire supplied with the appliance is replaced, it must be replaced with the same type, or its equivalent.

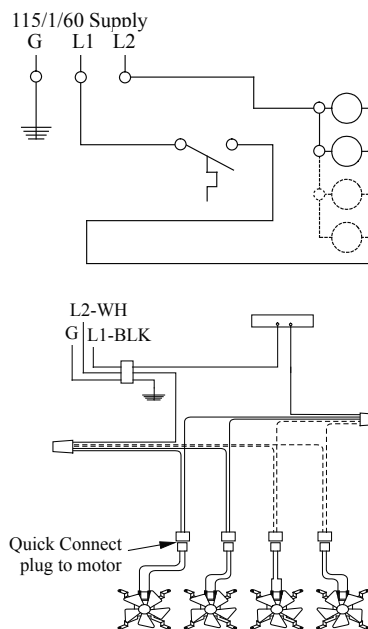

Figure 11. Wiring schematic for optional fans.